

Touch-Slide & Landing Board for Aircraft Carrier

Henry V. Pham

-- Specification --

A. Introduction

The **Touch-Slide & Landing Board for Aircraft Carrier** specification is based on the original document which is invented with State of The Art with the great gradually slide-to-stop methodology on the railroad that gradually wider on the other side which can automatically stop the sliding board eventually with less shocks in the shortest distance on the aircraft carrier. The **Touch-Slide & Landing Board** is required to build with strong lightweight material with the rubber helper wheels attached to the base frame that can be used to initiate the initial speed of the board at the moment the aircraft touching that sliding board, as needed, and the rail wheels rolling on the railroad when the aircraft touching the sliding board. The sliding board is set at an angle and should be always charged with electrical power at the ready position at the charger station which provides electrical battery power to the **Touch-Slide & Landing Board** mechanical that can able to flatten the sliding board and bring the entire sliding board to the landing home before the aircraft can get to the aircraft carrier floor.

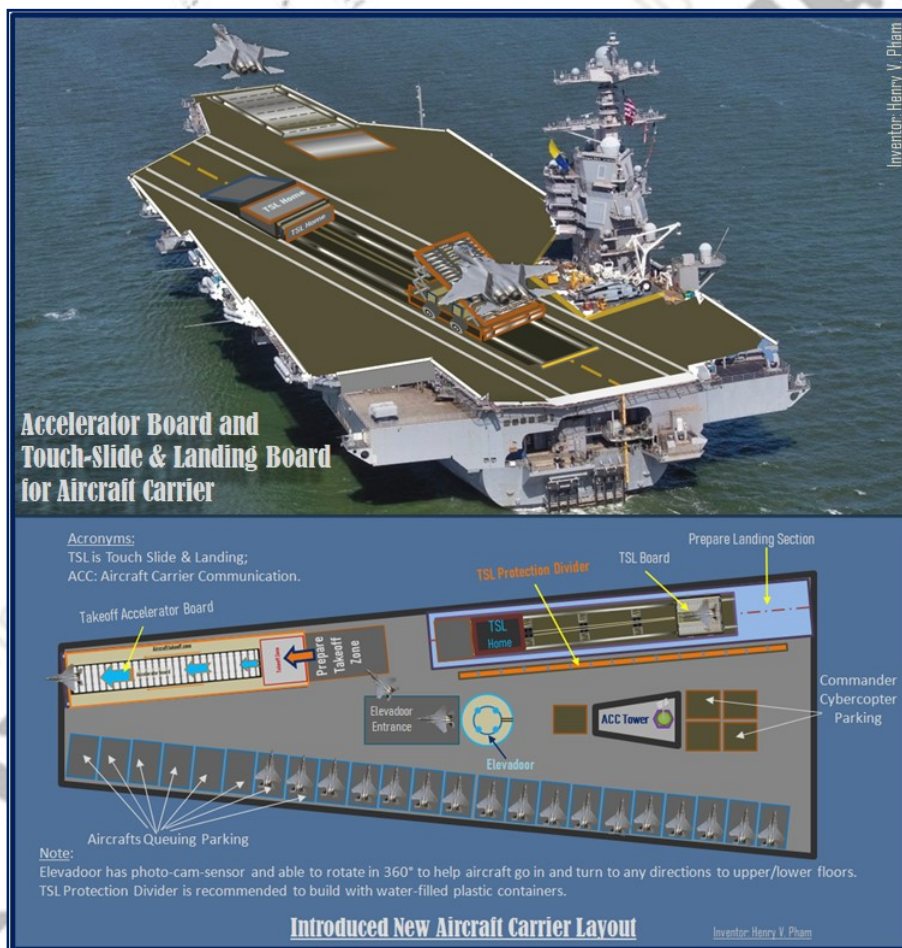

Figure-A1: Accelerator Board and Touch-Slide & Landing Board - Overview

The **Touch-Slide & Landing Board for Aircraft Carrier** is intended to replace the existing rope/cable catching aircraft and also provided the **Accelerator Board** to help aircraft takeoff faster. **Figure-A1: Accelerator**

Touch-Slide & Landing Board for Aircraft Carrier

Henry V. Pham

-- Specification --

Board and Touch-Slide & Landing Board – Overview shows the overview of the Accelerator board and the Touch-Slide & Landing board for the existing aircraft carriers and the new introduced aircraft carrier layout. The new introduced aircraft carrier is shown in later section in this invention document. **Figure-A2: Accelerator Board and Touch-Slide & Landing Board for Existing Aircraft Carrier- Overview** shows the existing aircraft carrier with the Accelerator Board which is recommended to build on the front of the aircraft carrier, and the Touch-Slide & Landing Board is recommended to build on the existing landing way with the same as existing landing direction. The aircraft carrier is recommended to provide with hand tugs to help towing the aircraft to the desired space to more organized aircraft parking after landing. The aircraft is also recommended to have at least a front lower view camera as shown in later section; this camera would help the pilot having a better landing view or ground view while takeoff or landing to eliminate the blind spots.

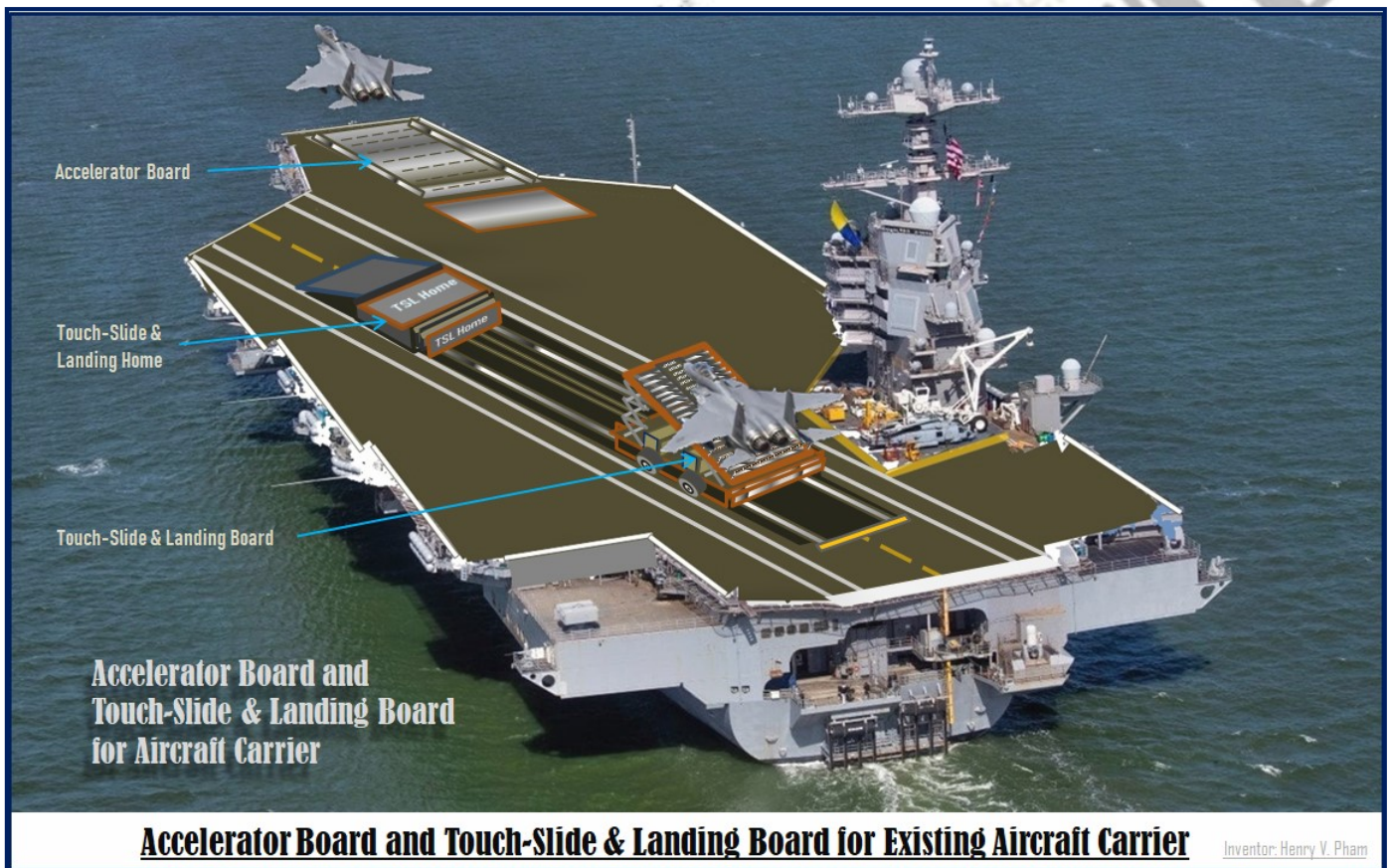

Figure-A2: Accelerator Board and Touch-Slide & Landing Board for Existing Aircraft Carrier- Overview

With these **Accelerator Board** and **Touch-Slide & Landing Board**, the aircraft can takeoff faster and landing safer in the shortest distance to reduce crashed with reducing space of rope extracting and detracting mechanism under the aircraft carrier floor in the compartment. This invention is the great promise for the future of aircraft carriers for better landing and takeoff in shortest distance with more space on the aircraft carrier which can provide better and safer for the pilots and commanders deploying troops for **peacean** keeper around the world through the ocean with more confident.

Touch-Slide & Landing Board for Aircraft Carrier

Henry V. Pham
-- Specification --

B. Touch-Slide & Landing Board and Railroad

The Touch-Slide & Landing (TSL) board should have the railroad expander at the center of the railroad, and the railroad expander controller should be on the landing home which is used to expand the railroad when the TSL board is brought to the ready position, and is used to re-parallel-align or release the railroad after the aircraft is completely landing on the board and the TSL board is completely stopped. **Figure-B1: Touch-Slide & Landing Board Railroad landing mode** shows the railroad expander and the railroad are connected to the spring box connectors for expandable railroad in landing mode with the railroad expander on.

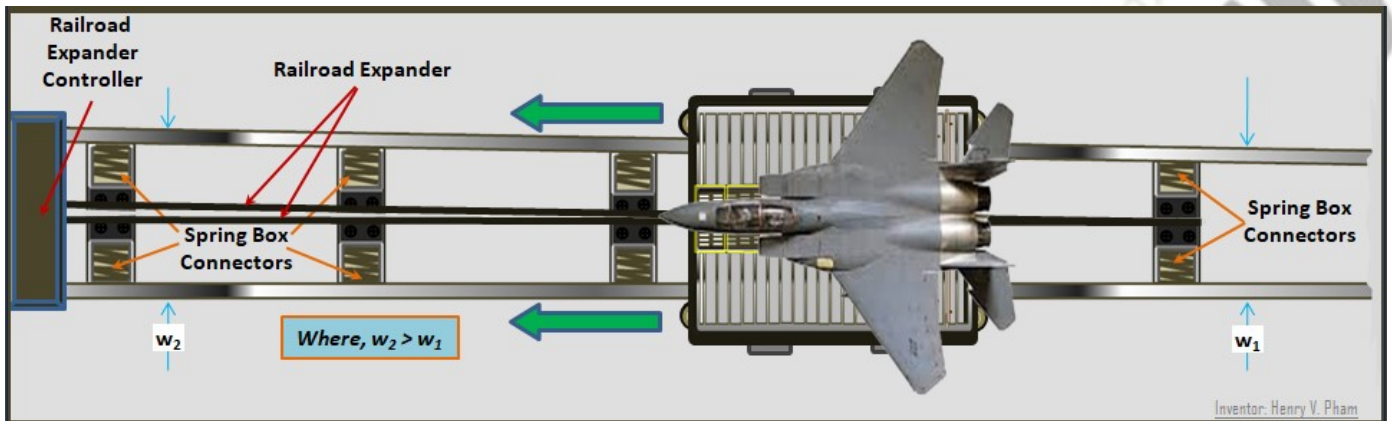

Figure-B1: Touch-Slide & Landing Board Railroad landing mode

Figure-B2: Touch-Slide & Landing Board Railroad Released mode shows the TSL board after the aircraft is already landed and go to the aircraft carrier floor with the railroad expander off to release the railroad so the TSL board can be easily moved to the ready position with charger adapter connected to the charger station.

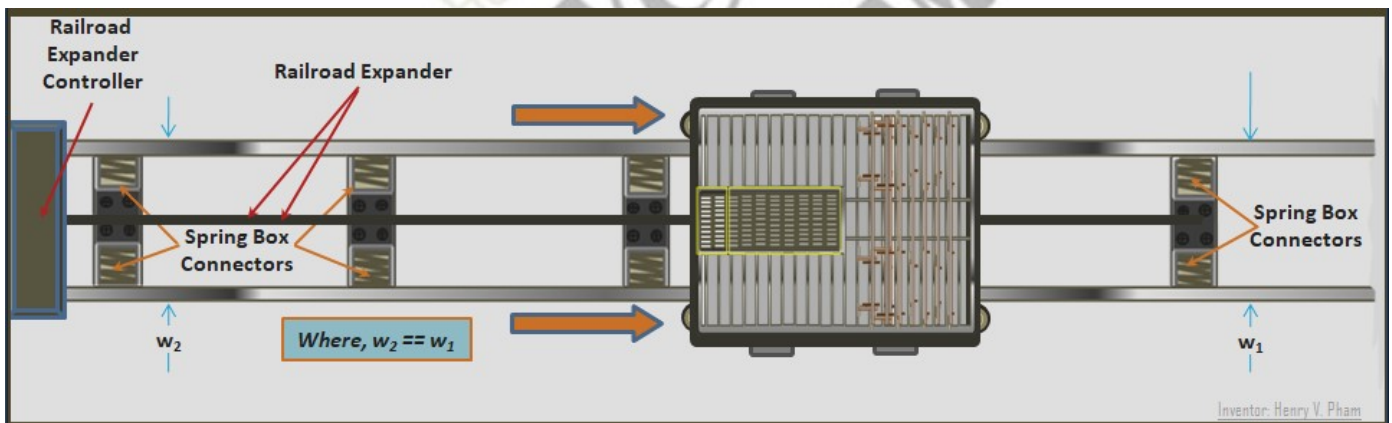

Figure-B2: Touch-Slide & Landing Board Railroad Released mode

Figure-B3: Touch-Slide & Landing Board Base (without Power-box & Gear Lifter) shows the TSL board base without power boxes and gear scissor lifter; the base has 4 rubber helper wheels, 2 wheels on each side; the base is required to have at least 6 bearing rail wheels, 3 wheels on each side; plus at least 4 rail wheels, 2 wheels on each side.

Touch-Slide & Landing Board for Aircraft Carrier

Henry V. Pham
-- Specification --

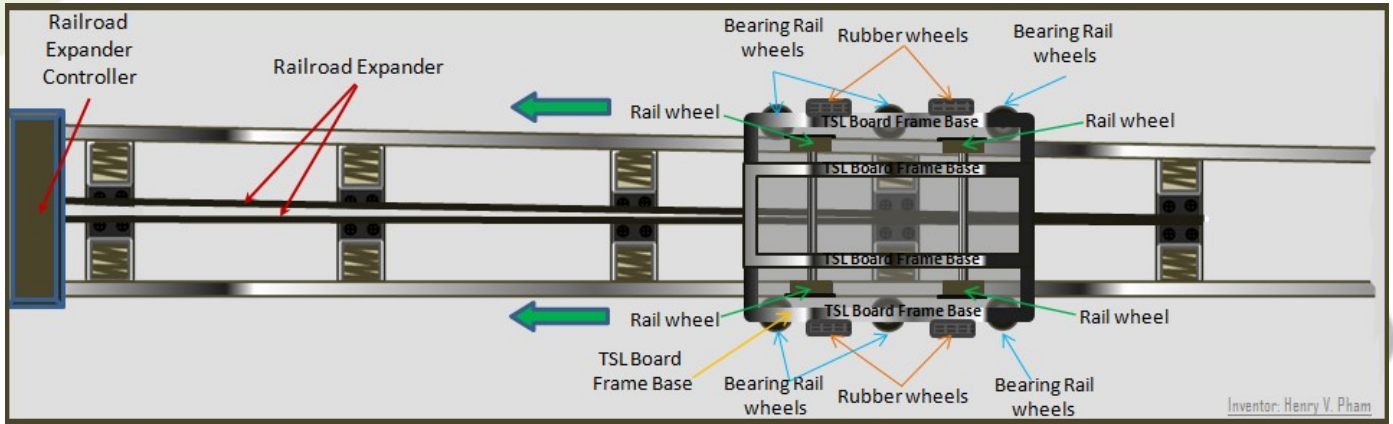

Figure-B3: Touch-Slide & Landing Board Base (without Power-box & Gear Lifter)

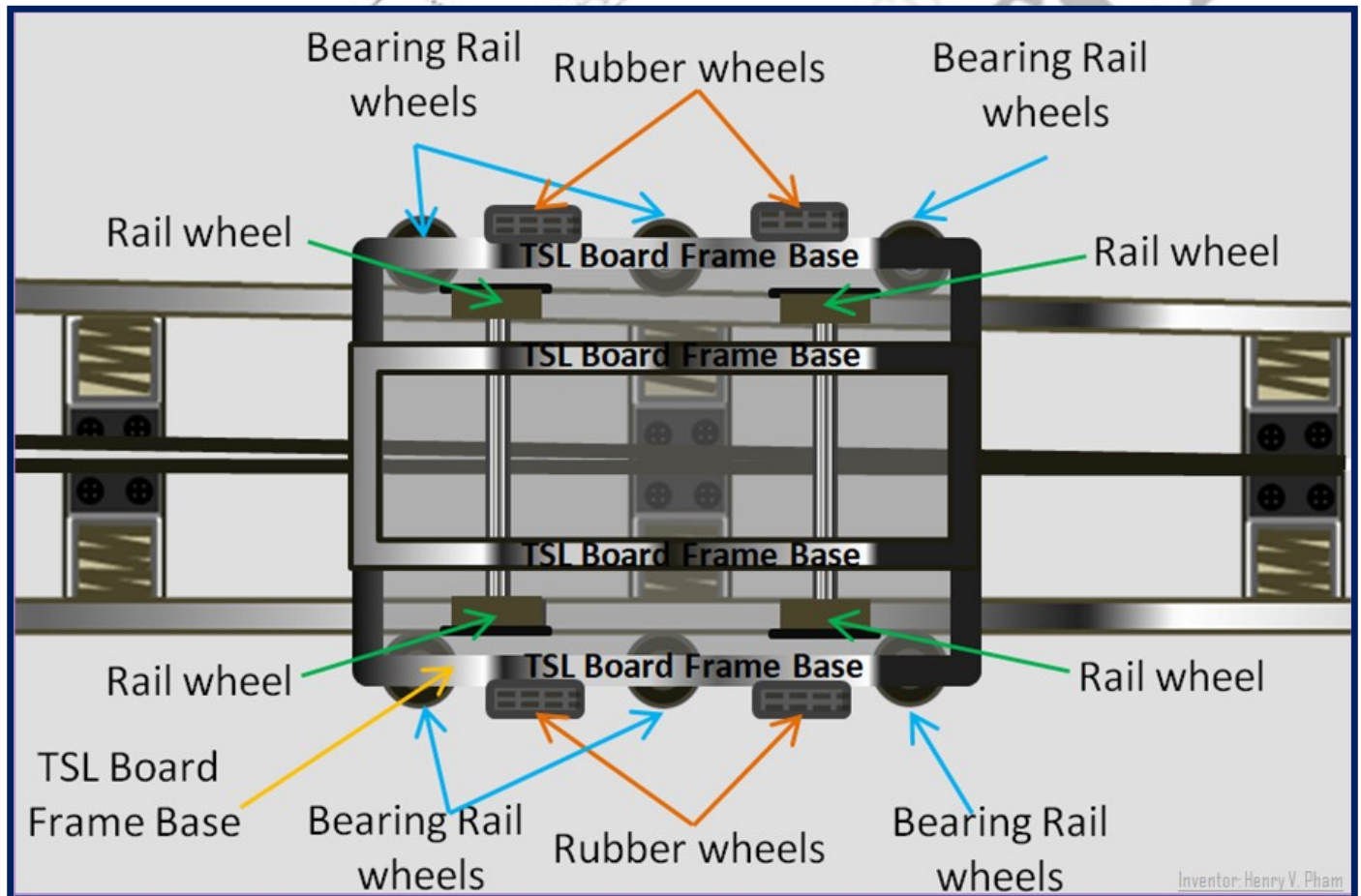

Figure-B4: Touch-Slide & Landing Board Frame Base - Closer view

Figure-B4: Touch-Slide & Landing Board Frame Base - Closer view shows a closer look of the TSL board base; the base with strong lightweight material which is recommended to use titanium, and the bearing rail wheels rolling horizontally on the outer edge of the railroad which makes the TSL board stop gradually when the

Touch-Slide & Landing Board for Aircraft Carrier

-- Specification --

bearing rail wheels get to the wider section of the expanded railroad. The base should be built as lightweight as possible so the TSL board can slide when the aircraft touching the TSL board.

The rubber helper wheels are controlled by the auto-trigger initial speed controller mechanism that is used battery power. The rubber helper wheels should be powered and initiated a speed less than $\frac{1}{2}$ speeds of the common landing aircraft and should be running with maximum length of $\frac{1}{3}$ of the railroad length. Note that the initiated speed of the rubber helper wheels can be adjusted or reduced depends on the friction and the weight of the TSL board that allow the aircraft to touch and slide within the non-expanded railroad. If the TSL board is built with less friction and lightweight material that the TSL board can slide right at the moment of the aircraft touching, then rubber helper wheels powered initiated speed can be eliminated. The rubber helper wheels are needed to roll back the TSL board to the ready position and charged after the aircraft is landed completely and the TSL board is empty.

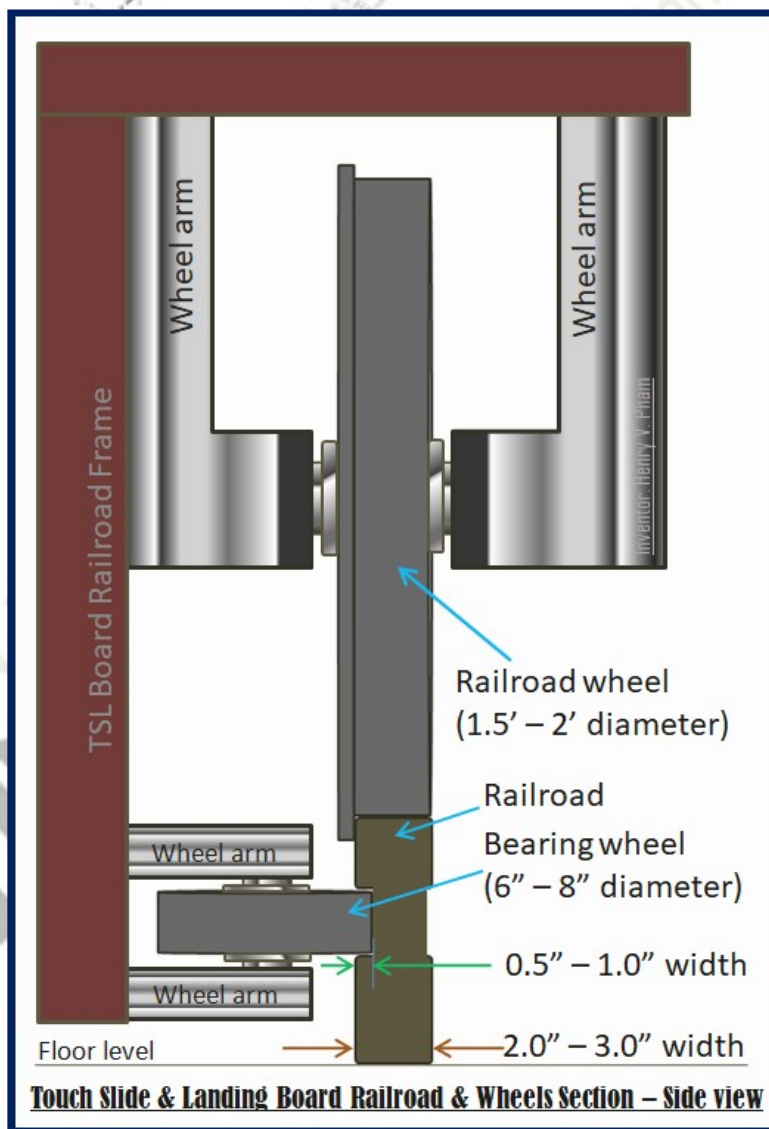

Figure-B5: Touch-Slide & Landing Board Railroad & Wheels section

Touch-Slide & Landing Board for Aircraft Carrier

-- Specification --

Figure-B5: Touch-Slide & Landing Board Railroad & Wheels section shows the railroad, bearing rail wheels and rail wheels. The railroad width is recommended within the range of 2 inches to 3 inches width which can be expandable within the expander section. The bearing deep is recommended within 0.5 inch to 1 inch; and the bearing rail wheel diameter is recommended within 6 inches to 8 inches. The railroad wheel is used to hold and balance the TSL board on the railroad which is recommended with diameter within 1.5 feet to 2 feet as shown in figure above.

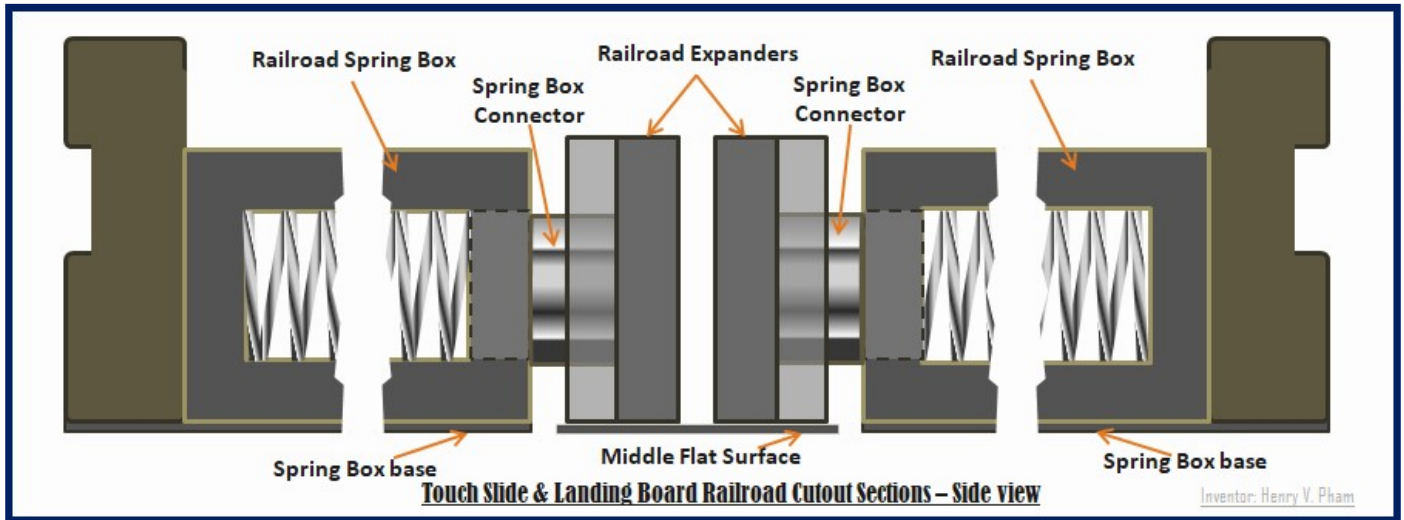

Figure-B6: Touch-Slide & Landing Board Railroad Cutout section -- Side view

Figure-B6: Touch-Slide & Landing Board Railroad Cutout section -- Side view shows the railroad and spring box connectors cutout section. The spring box is connected to the spring box base with slide-able base slot for the railroad within the expander railroad section; and the spring box is connected to the railroad expander for both sides as shown in figure above. Note that the spring should be strong enough to push the railroad out gradually to desired width that strong enough to stop the TSL board when the aircraft touching and sliding on the board. The base of the railroad expanders should be flat surface as shown. The TSL railroad is recommended to test on the ground first with the long railroad with all the support aircrafts to find out the best length that suitable for aircraft carrier before install on the aircraft carrier.

Figure-B7: Touch-Slide & Landing Board Railroad sections - Top view shows the spring box connectors are recommended to separate by 1.5 meters to 2.5 meters for $\frac{1}{2}$ of the entire railroad; the expandable railroad is recommended to be $\frac{1}{2}$ of the entire railroad as shown. The width of the railroad is recommended at least equal to the wider separated back wheels of the supported aircrafts and maximum width with additional 1 meter. For instance, aircraft F-15 with the back wheels separated by 3 meters, then the railroad is recommended within 3 meters to 4 meters. The TSL board width is recommended with at least equal to the wider separated back wheels of the supported aircrafts plus additional 2 meters with total of 5 meters width (additional 1 meter on each side); but not recommended to have wider than the wing body. For instance, aircraft F-15 has the wingspan of 10.7 meters, and the wing body which is used to carry bomb with the length side-to-side about 6.5 meters.

Touch-Slide & Landing Board for Aircraft Carrier

Henry V. Pham
-- Specification --

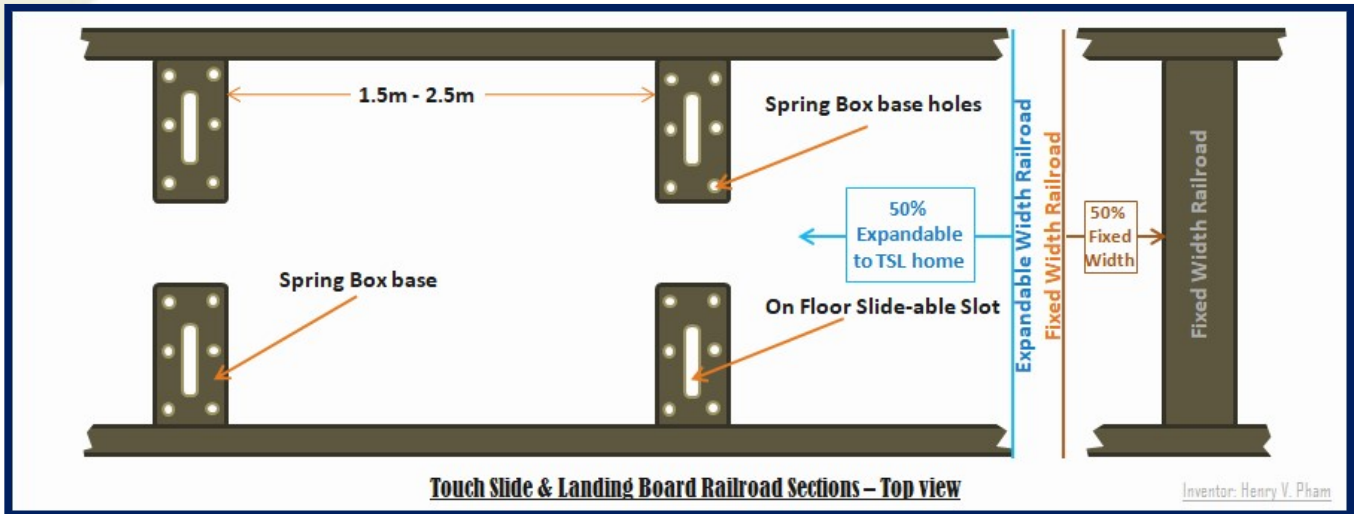

Figure-B7: Touch-Slide & Landing Board Railroad sections – Top view

Figure-B8: Touch-Slide & Landing Board Base, Charge Adapter & Charger Station – Top view shows the TSL board width at least equal to the wider separated back wheels of the supported aircrafts plus additional 2 meters, and should not wider than the wing body of the aircraft.

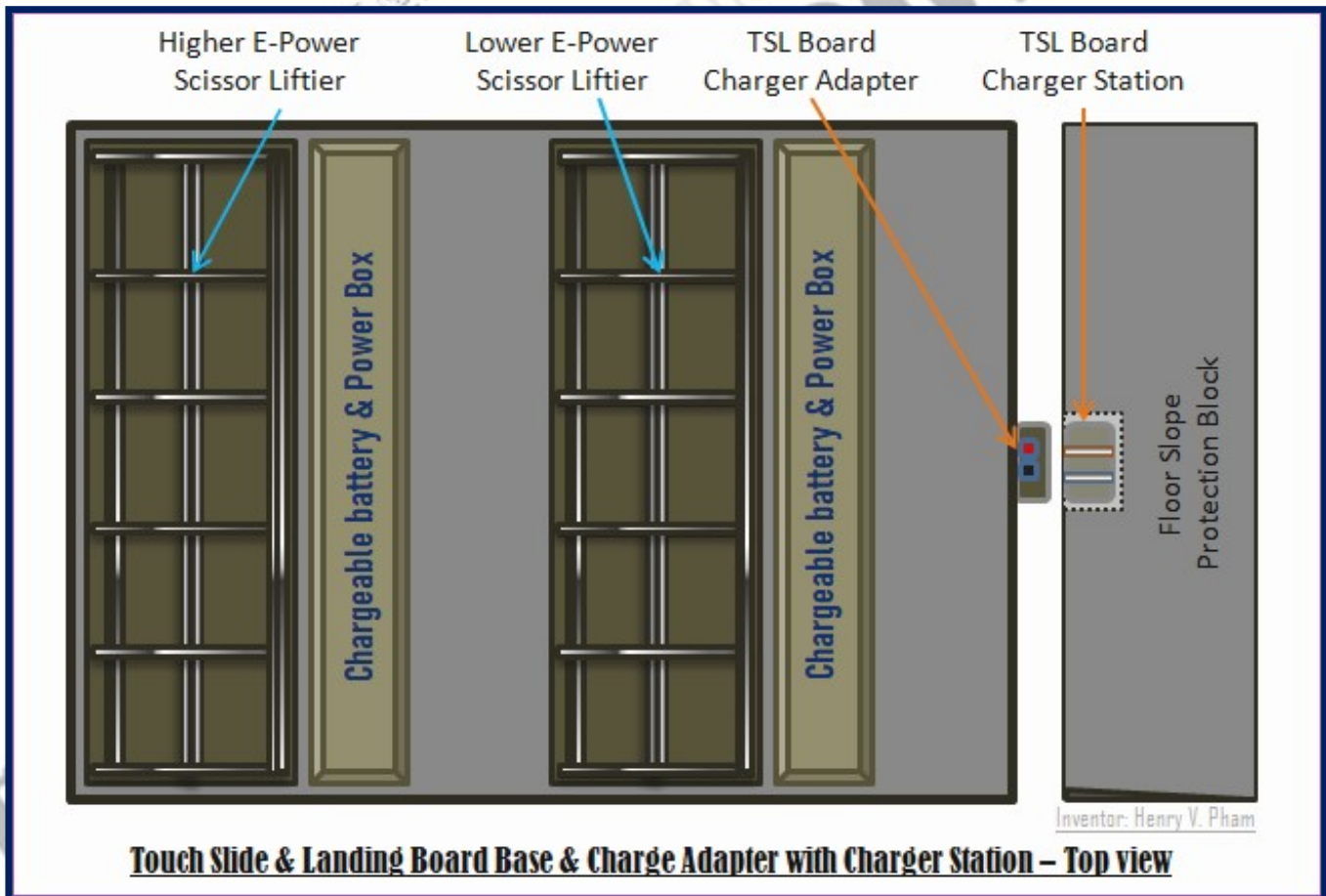

Figure-B8: Touch-Slide & Landing Board Base, Charge Adapter & Charger Station – Top view

Touch-Slide & Landing Board for Aircraft Carrier

-- Specification --

This figure shows the TSL board base with E-Power Gear Scissor Lifters for both lower and higher sections; and recommended with 2 chargeable batteries and power boxes for backup and for power controller of each lifter. The TSL board is recommended always charged and have power ready when it is rolled to the ready-to-slide position. The battery power on both boxes can also be used to power the light indicators with optional camera on the board to record the landing as an option. The TSL board charger adapter is touch-and-charge option and recommended with waterproof with a cover as shown in above and in **Figure-B9: Touch-Slide & Landing Board Base, Charge Adapter & Charger Station – Side view**. The TSL board charger adapter is recommended to build at the bottom, and the charger station which is on the floor slope protection block, are built with protection as shown in figure below. Both TSL board base and the Charger Station should have charger indicators. The floor slope protection block should be built in angle with the high equal to the lowest side of the TSL board at the ready-to-slide position as shown in figure below. This floor slope protection block is used for the pilot aware that the aircraft must fly above this slope to avoid the aircraft tail touching on the floor while landing on the TSL board.

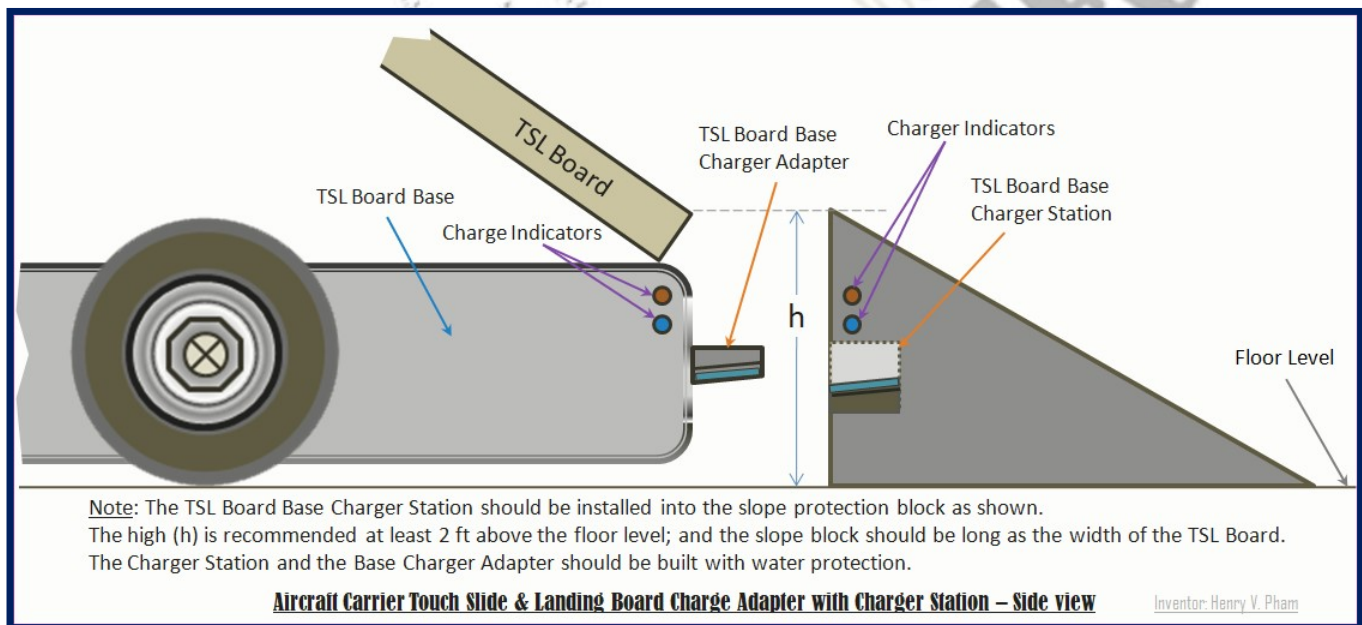

Figure-B9: Touch-Slide & Landing Board Base, Charge Adapter & Charger Station – Side view

C. Touch-Slide & Landing Board in Operating Mode

Figure-C1: Touch-Slide & Landing Board Ready mode shows the TSL board is recommended to control and roll to the ready-to-slide position by at least 2 persons and make sure the charger indicators are on and the TSL board system is in ready mode as shown before leaving the TSL board area. Figure below shows detail dimensions of the TSL board. The TSL board length 'L' should be equal to the length of the common large supported aircraft length; the high 'H' is the height of TSL board slope at ' α ' angle and 'W' is the width of TSL board, this angle is recommended between 20° to 35° degrees. For instance, aircraft F-15 with the length of 15.7 meters, the high 'H' is required to raise the board to 9 meters and 'W' is 12.86 meters for

Touch-Slide & Landing Board for Aircraft Carrier

-- Specification --

35° degrees. The Gear Scissor Lifter with multiple levels can be used to raise the TSL board for both lower and higher sections. However, only one bar fixed joint is required to attach to the TSL board as shown in figure below in red joint of the higher Gear Scissor Lifter, the other lying positions of the TSL board are roll-able along the lower Gear Scissor Lifter roller; note that both Gear Scissor Lifters are one-side lifter. The TSL board when flatten, it requires to lower the higher Gear Scissor Lifter first until equal to the level of the lower one, then both Gear Scissor Lifters are slowly flatten down to the lowest level the moving to the TSL home for the aircraft get to the floor as shown in later sections.

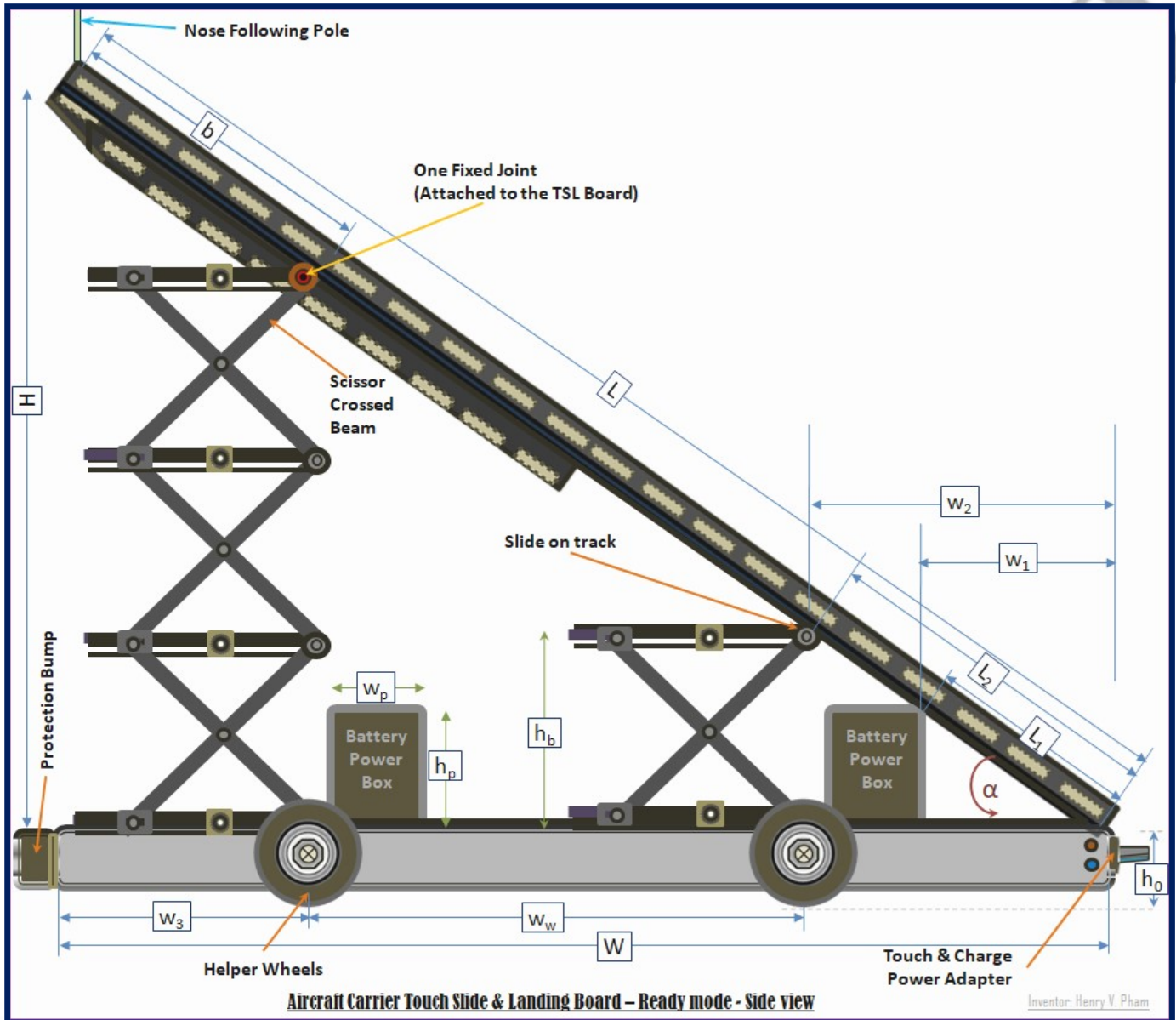

Figure-C1: Touch-Slide & Landing Board Ready mode

Note that the battery power box (high h_p) cannot be higher than the TSL home; and the TSL board can use the power box as the base to flatten for more support. As shown in figure below, let use Gear

Touch-Slide & Landing Board for Aircraft Carrier

-- Specification --

Scissor Lifter with 3 levels, and each level with maximum raise high of 2.25 meters, then the beam for the Scissor Lifter is 3.2 meters; note that the length 'b' should be longer or equal to the scissor beam of 3.2 meters to cover the board-to-home tip and the length 'w₃' plus bumper should be shorter or equal to 'b'. The high 'h_b' is 2.25 meters, same as the maximum raise high of one level scissor lifter; then 'L₂' is 3.92 meters; where 'L₁' is related to the high of TSL home. Let TSL home high is 1.5 meters and 2 feet (0.61 meter) high of the TSL board; then the high 'h_p' is 0.89 meters. So, 'L₁' equals 1.55 meters based on 35° degrees 'α' angle. The width 'W_w' separated of the 2 rubber helper wheels is recommended to be ½ of the width of the entire TSL board. The Nose Following Pole option is to provide the pilot a point to aim while landing on TSL board; note that is optional since the aircraft has only one pilot seat on straight line and recommended the aircraft to equip with a front lower view camera which provide better view for pilot and better for future of aircrafts.

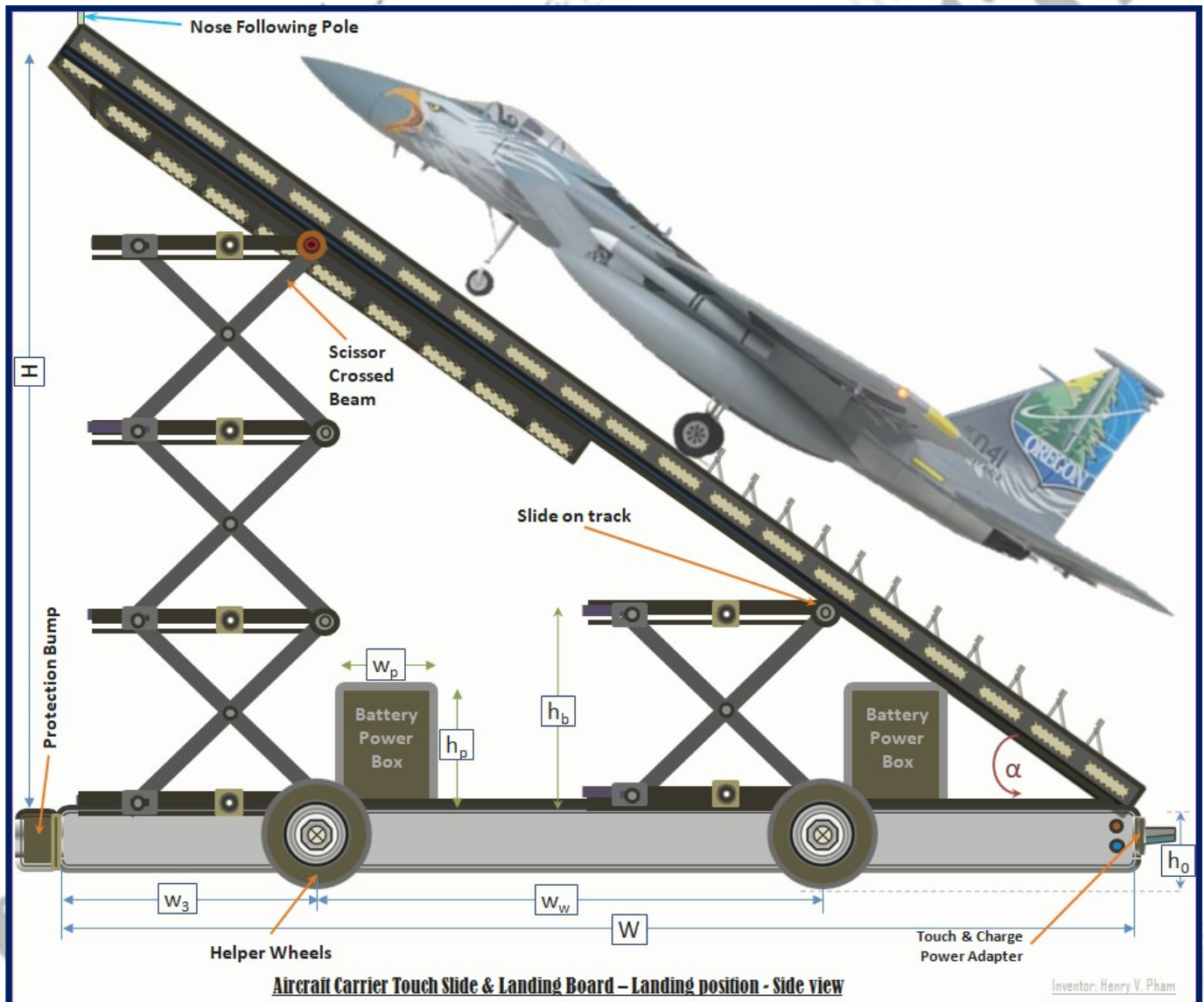

Figure-C2: Touch-Slide & Landing Board landing position

Touch-Slide & Landing Board for Aircraft Carrier

-- Specification --

Figure-C2: Touch-Slide & Landing Board landing position shows the aircraft touch and slide positions. When the aircraft touching the TSL board, the board slides out and lose power connection and trigger the rail raised wheel locks one by one until touch the back wheel of the aircraft to lock the back wheels as shown. The TSL board must be built to slide with a touch of aircraft to trigger the slide-off switch even the TSL board is built with the rubber helper wheels to initiate helper speed.

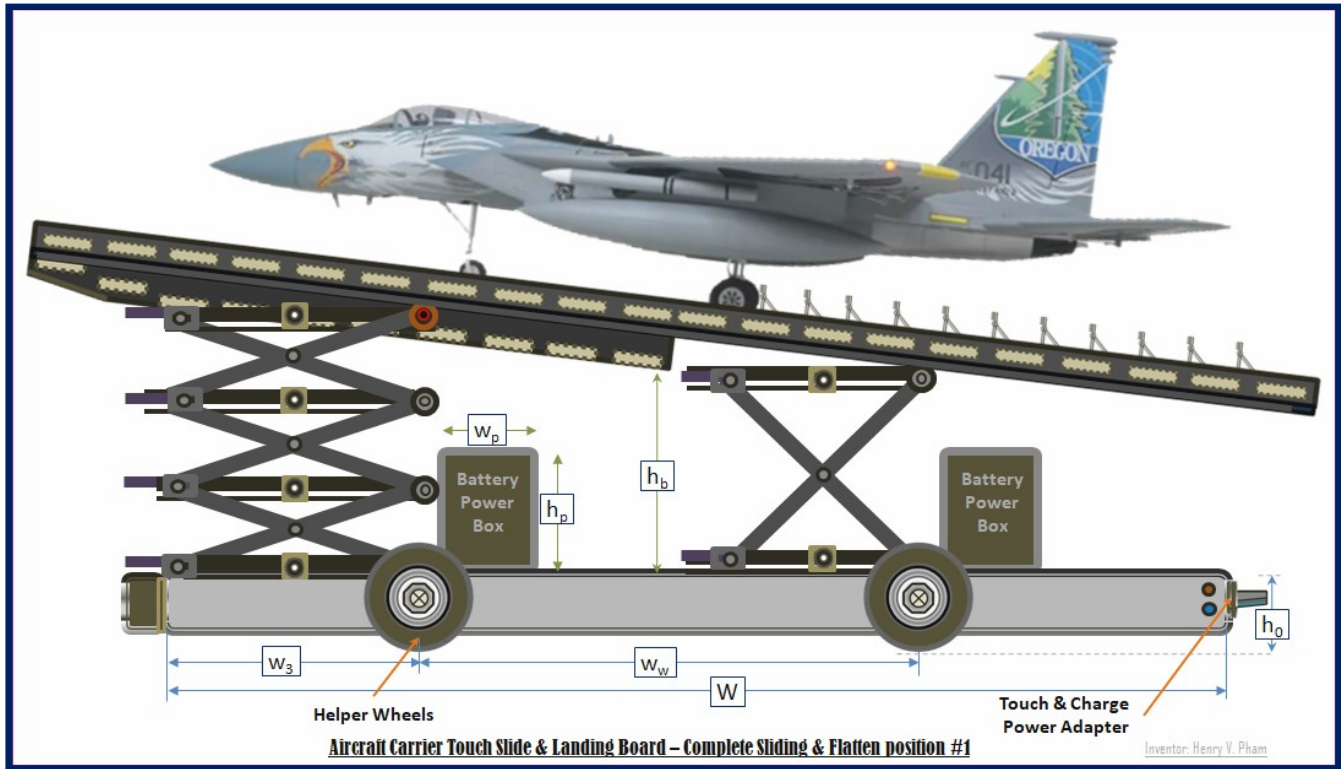

Figure-C3: Touch-Slide & Landing Board Complete Sliding & Flatten position 1

Figure-C3: Touch-Slide & Landing Board Complete Sliding & Flatten position 1 shows after the aircraft is completely landed on the TSL board, the TSL board is flattening with 1st stage either by automatic programming or by human controlling as shown. The higher Gear Scissor Liftier will lower the TSL board in 1st stage flattening to the same level of the lower Gear Scissor Liftier. The TSL railroad expander can be operated right after the 1st stage flattening completed, and the TSL board can be ready to move forward to the TSL home by the rubber helper wheels as shown in **Figure-C4: Touch-Slide & Landing Board Complete Sliding & Flatten position 2**. The TSL board can be flatten in 2nd stage simultaneously while the TSL board is moving forward to the TSL home for faster landing process. **Figure-C5: Touch-Slide & Landing Board Complete Sliding & Flatten position 3** shows the TSL board is flatten to the lowest level and the aircraft would be ready to roll on to the TSL home to get to the floor. Note that the Gear Scissor Liftier is needed with some angle to lift up again after flatten to the lowest level. From the calculation above shown the high ' h_p ' is 0.89 meters; this would be the space with approximately 1 foot high of slope for each scissor beam of the 3-level scissor liftier. If this slope is not enough to lift up, a support initial air lift on a side can be used to help the Gear Scissor Liftier at the initial lifting operation. The initial air lift can be built right at the one fixed joint line to lift straight up and release

Touch-Slide & Landing Board for Aircraft Carrier

Henry V. Pham
-- Specification --

about another meter without attaching to the TSL board. When the TSL board is docked on to the TSL home, the aircraft can roll on top of the landing elevation base of the TSL home to the aircraft carrier floor level through a floor slope as shown in **Figure-C6: Touch-Slide & Landing Board Complete Landing & Drive to Floor position.**

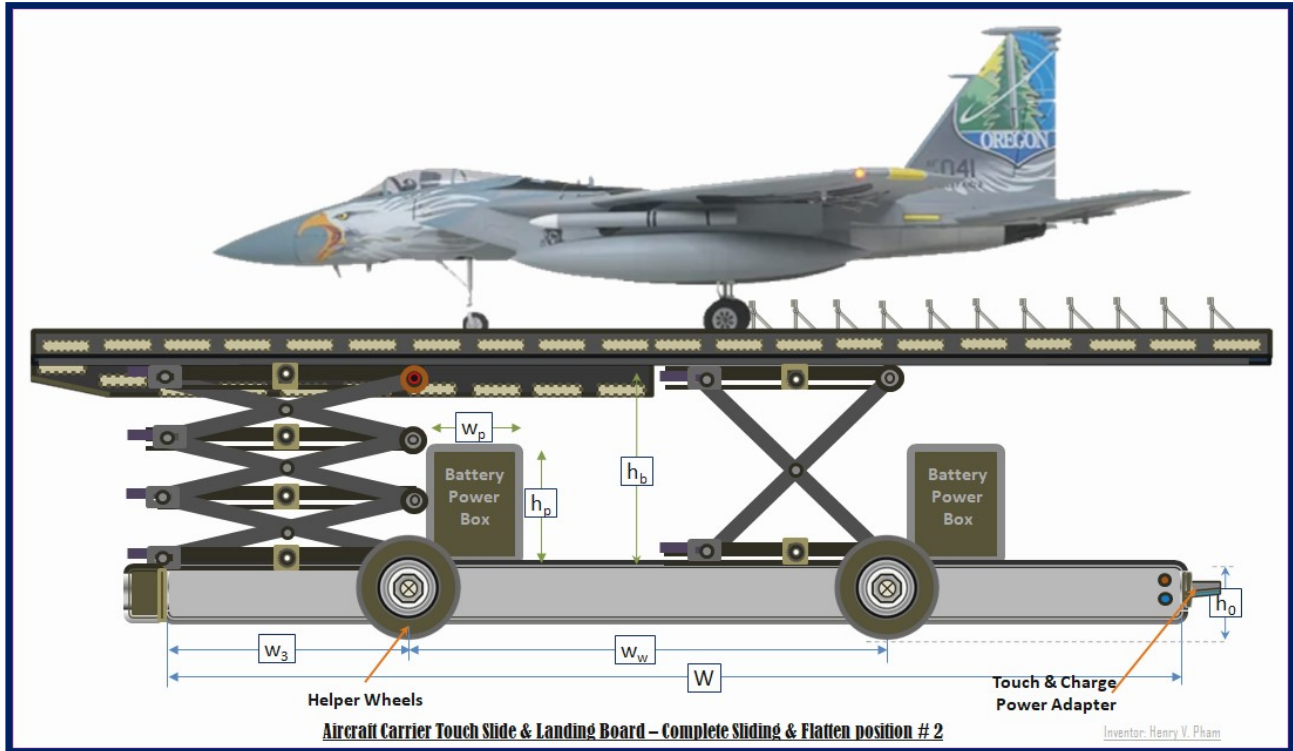

Figure-C4: Touch-Slide & Landing Board Complete Sliding & Flatten position 2



Figure-C5: Touch-Slide & Landing Board Complete Sliding & Flatten position 3

Touch-Slide & Landing Board for Aircraft Carrier

Henry V. Pham

-- Specification --

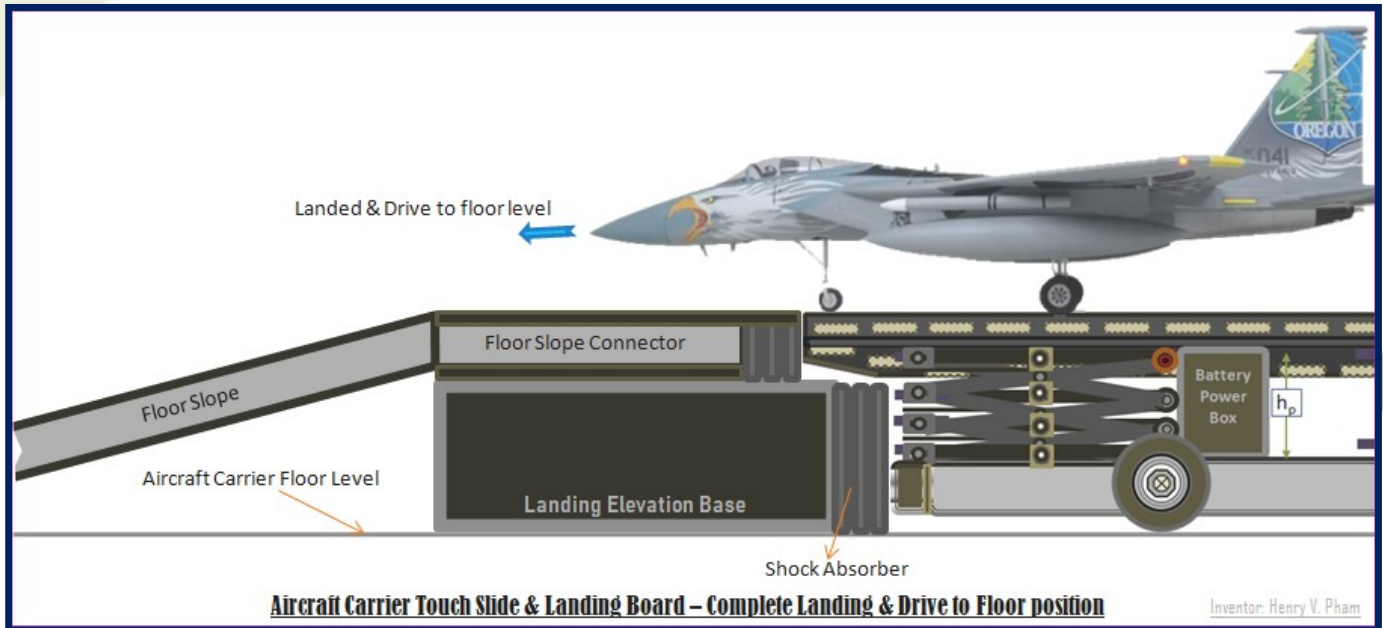

Figure-C6: Touch-Slide & Landing Board Complete Landing & Drive to Floor position

D. Touch-Slide & Landing Board Frame

Figure-D1: Touch-Slide & Landing Board without Rail Wheels Locks shows the TSL board frame is shown. The TSL board frame is recommended to build with lightweight strong material with more open spaces of grid to reduce the wind force that may affect the sliding during landing. This figure shows top and front views of the TSL board without the vertical rail wheels locks. The width 'w' of each grid is recommended equal to the minimum radius of the smallest aircraft wheels to prevent from the aircraft wheel getting stuck. The deeper area at the center of the frame base is used as front wheel holder; the width 'w_f' is recommended with at least 1 meter and the length from 1/3 to 1/2 of the TSL board; the deep is recommended within ¼ to ½ of the supported aircraft front wheels diameter. The purposes of the deep front wheel holder is provide the pilot with better aim front wheel on it and prevent from out of bounce, plus the deep can keep the aircraft front side lower than the back for better protection from falling down even with foldable raised rails wheel locks. The deep front wheel holder is recommended to build in grid and the width of each grid gap about ½ of the width of the smallest supported aircraft; and the deep front area would have a slope for the front wheel to rollover. **Figure-D2: Touch-Slide & Landing Board without Wheels Locks - Side view** shows the side view of the TSL board without rails wheel locks.

Touch-Slide & Landing Board for Aircraft Carrier

Henry V. Pham

-- Specification --

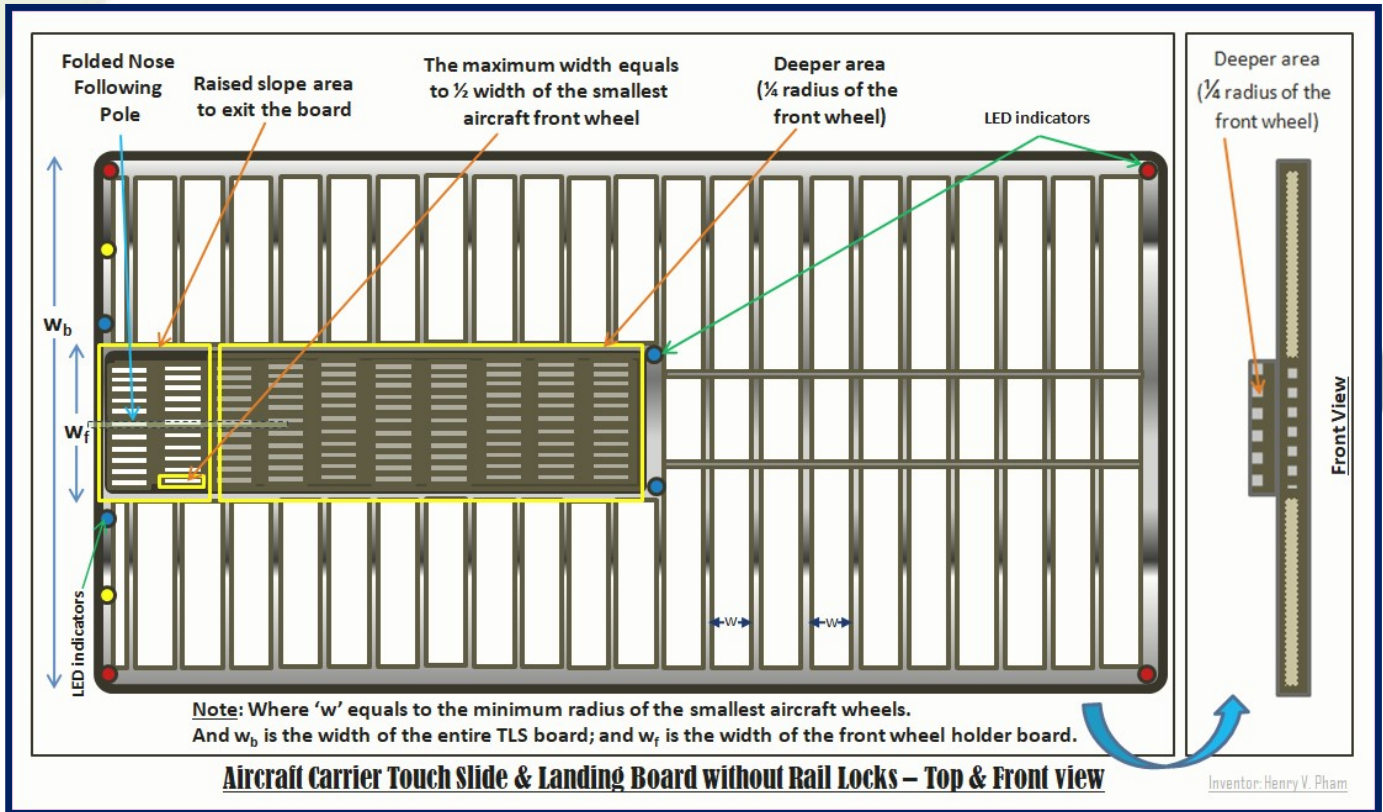

Figure-D1: Touch-Slide & Landing Board without Rail Wheels Locks

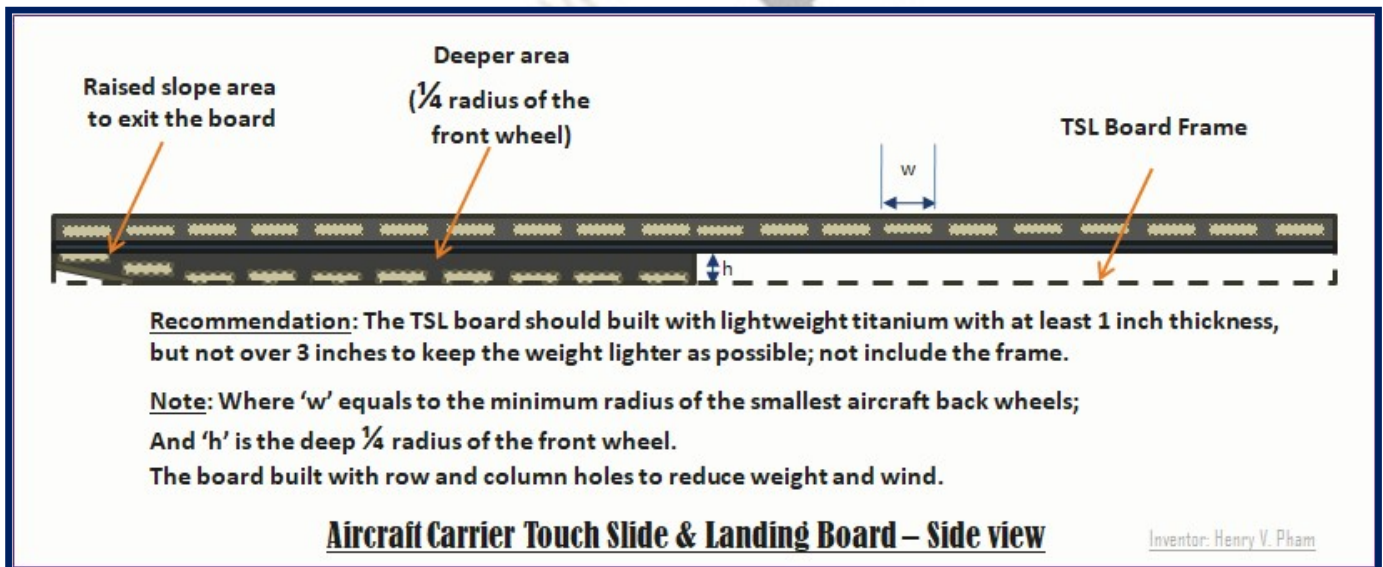

Figure-D2: Touch-Slide & Landing Board without Wheels Locks – Side view

Figure-D3: Touch-Slide & Landing Board with Rail Wheels Locks shows the rails wheel locks on top of the TSL board base in folded mode. When the aircraft touching the TSL board and the board slide out of the charger and trigger the landing switch, the rail wheels locks mechanical would be triggered to raise the foldable rails

Touch-Slide & Landing Board for Aircraft Carrier

-- Specification --

up vertically from the TSL board base to protect the aircraft from rolling down of the board. The height of the rail wheel locks is recommended to be $\frac{1}{2}$ of the supported aircraft back wheels diameter so the rails can touch and hold back wheels right at the maximum 90° degrees derivative vector at the touching point to the TSL board base. The array of rail wheel locks is recommended to install up to $\frac{1}{3}$ of the length of the TSL board from the lower edge of the board. When the TSL board is slide out and the landing switch is triggered, the rail wheel locks will be triggered to lock the back wheels starting from the lowest rail wheel lock first; when the first rail wheel lock is completely raised to 90° degrees, then the next rail switch can be triggered for the next rail to rise with the frequency within 5 seconds, the amount of time expect all wheels touched on board even front wheel touching first, for all the rail wheel locks. Note that the rails are close enough to each other so when the back wheels touching on any rail, that rail will be stay.

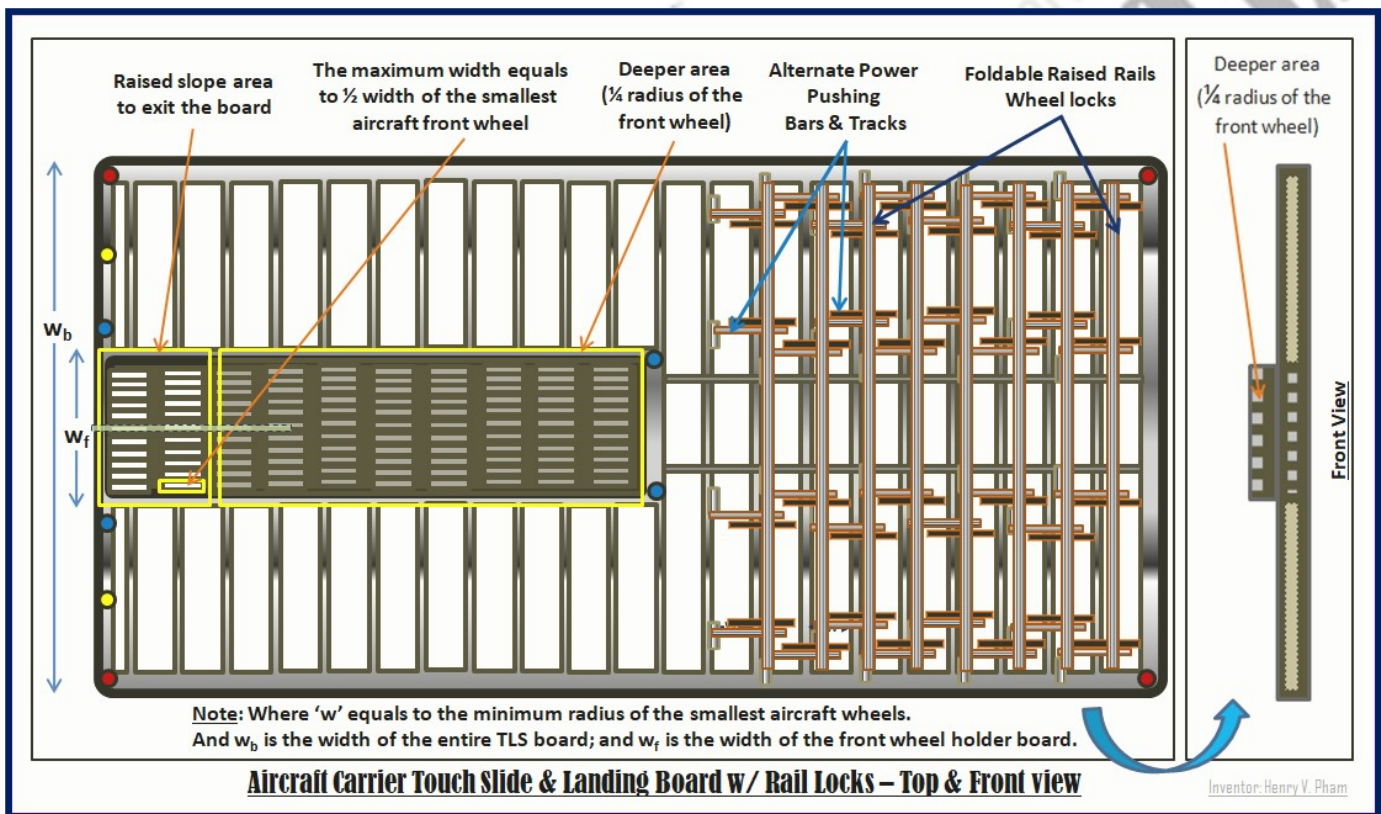

Figure-D3: Touch-Slide & Landing Board with Rail Wheels Locks

Figure-D4: Touch-Slide & Landing Board with Rail Wheels Locks Details shows the foldable raised rails wheel locks. The rail wheel lock unit which is a zommified cutout section is one of the rail wheel locks that is shown in detail of top and side views. The raised bar is controlled by a gear motor which can turn the raised bar 90° degrees angle. The raised bars are connected together to a rail lock bar which is used to hold the aircraft back wheels that can raise entire rail lock to lock entire row. While the raised bar motor is turned, the side bar chain motor spins and pull the chain belt that can pull the raise slide bar closer and rise the raised bar higher up to 90° degrees angle as shown in rail lock unit side view. The raised slide bar is connected to the chain belt to a joint which holds the chain belt to pull when the slide bar chain motor is turning. The

Touch-Slide & Landing Board for Aircraft Carrier

-- Specification --

rail wheel locks will rise one-by-one from the lower edge of the TSL board up until touch the aircraft back wheel as mentioned above; the raised bar motor and slide bar chain motor can turn in revert direction to fold the rail wheel locks back to the TSL board base when the landing is completed and the TSL board is empty.

The LED light indicators on the TSL board are shown in pattern that the pilot can easily see and recognize; the red LED indicators are recommended to install on the outer of the TSL board and flashing when the TSL board is not ready to land. The green LED indicators are turned solid green when the TSL board is ready to land with the yellow and red indicators are in lower intensity compare to the green indicators. The TSL board is recommended always move to the ready-to-slide station and charged to have enough power for the TSL board LED lights, liftier motors and rail wheel lock mechanism.

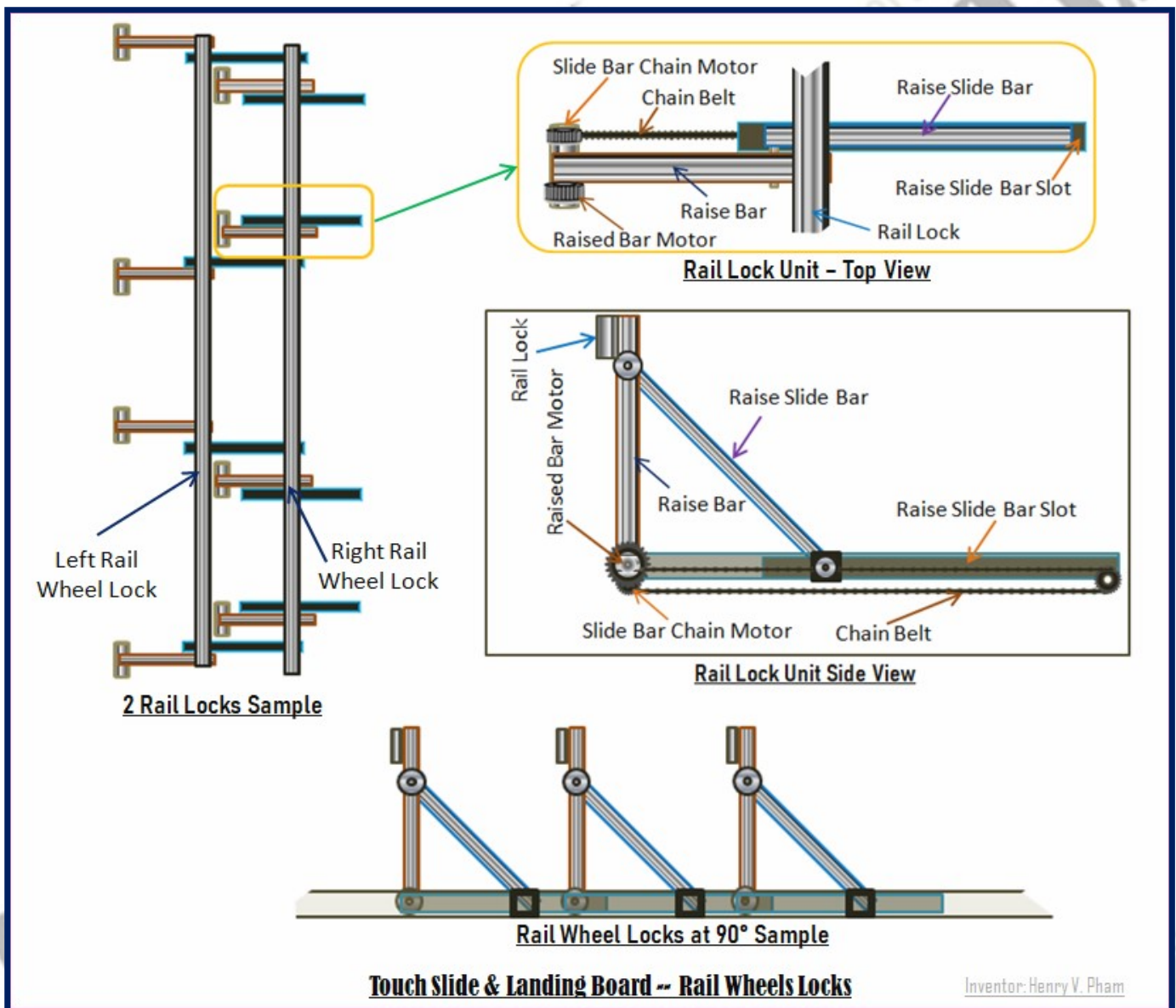

Figure-D4: Touch-Slide & Landing Board with Rail Wheels Locks Details

Touch-Slide & Landing Board for Aircraft Carrier

-- Specification --

Figure-D5: Touch-Slide & Landing Board Landing Wheels with 3-Point Forces Scenarios shows 6 possible scenarios that may happen. When building and testing the TSL board, the recommendation is to make sure to test the 3-point forces in worse case scenarios to ensure the TSL board can handle when the pilot could not keep the aircraft right at the center of the TSL board for any reasons. The 3-point forces landing scenario 1 is the perfect scenario with expected that both back wheels touch the board first, then the front wheel touching after within the center or expected wheels touching areas. The 3-point forces landing scenario 2 is the front wheel touching the board after the back left wheel touching and the back right wheel touching last; this case the board is needed to build and test to ensure the stability of the TSL board at the lower left corner. The 3-point forces landing scenario 3 is the front wheel touching the board after the back right wheel touching and the back left wheel touching last; this case the board is needed to build and test to ensure the stability of the TSL board at the lower right corner. The 3-point forces landing scenario 4 is the front wheel touching the board before both the back wheels touching within the center or expected wheels touching areas; this case the board is needed to build and test to ensure the stability of the TSL board plus the rail wheel locks mechanical to ensure the rail wheel locks can hold the back wheels correctly in timing as expected in the normal landing with back wheels touching first. The 3-point forces landing scenario 5 is the front wheel touching the board before the back left wheel touching and the back right wheel touching last; this case the board is needed to build and test to ensure the stability of the TSL board at the lower left corner of the TSL board plus the rail wheel locks mechanical to ensure the rail wheel locks can hold the back wheels correctly in timing as expected in the normal landing with back wheels touching first. The 3-point forces landing scenario 6 is similar to the scenario 5 but it is needed to build and test the mechanical timing and the stability of the TSL board at the lower right corner.

Applying Newton's second law: $F = ma = m (dv/dt)$; acceleration is considered the average velocity per second at any given time (v/t); the force F can be used to calculate the maximum force that applying to the TSL board to test the worst scenarios for the wheels at the worst locations as shown in the figure above; and as we already know m is the mass of the aircraft in the equation above in this case. The TSL board is recommended to build, test and adjust as needed to support the desired landing aircrafts on the ground before install and test again on the aircraft carrier. The training recommendation for the pilot can be prepared with a virtual LED board with different sliding angle from $20^\circ - 35^\circ$ degrees, and let the pilot fly through the virtual LED board plane with a given ahead preparation distance from 25 meters – 100 meters. After the pilots are already passed and certified the virtual LEDs landing tests and on the ground tests, then the real tests on the aircraft carrier can be started for safer testing procedures. The TSL board can be built on the ground and test with the long railroad to test the friction of the TSL board to find out the maximum length of the TSL board railroad that needs to support all the aircrafts that needed before installed on the aircraft carrier.

Touch-Slide & Landing Board for Aircraft Carrier

Henry V. Pham
-- Specification --

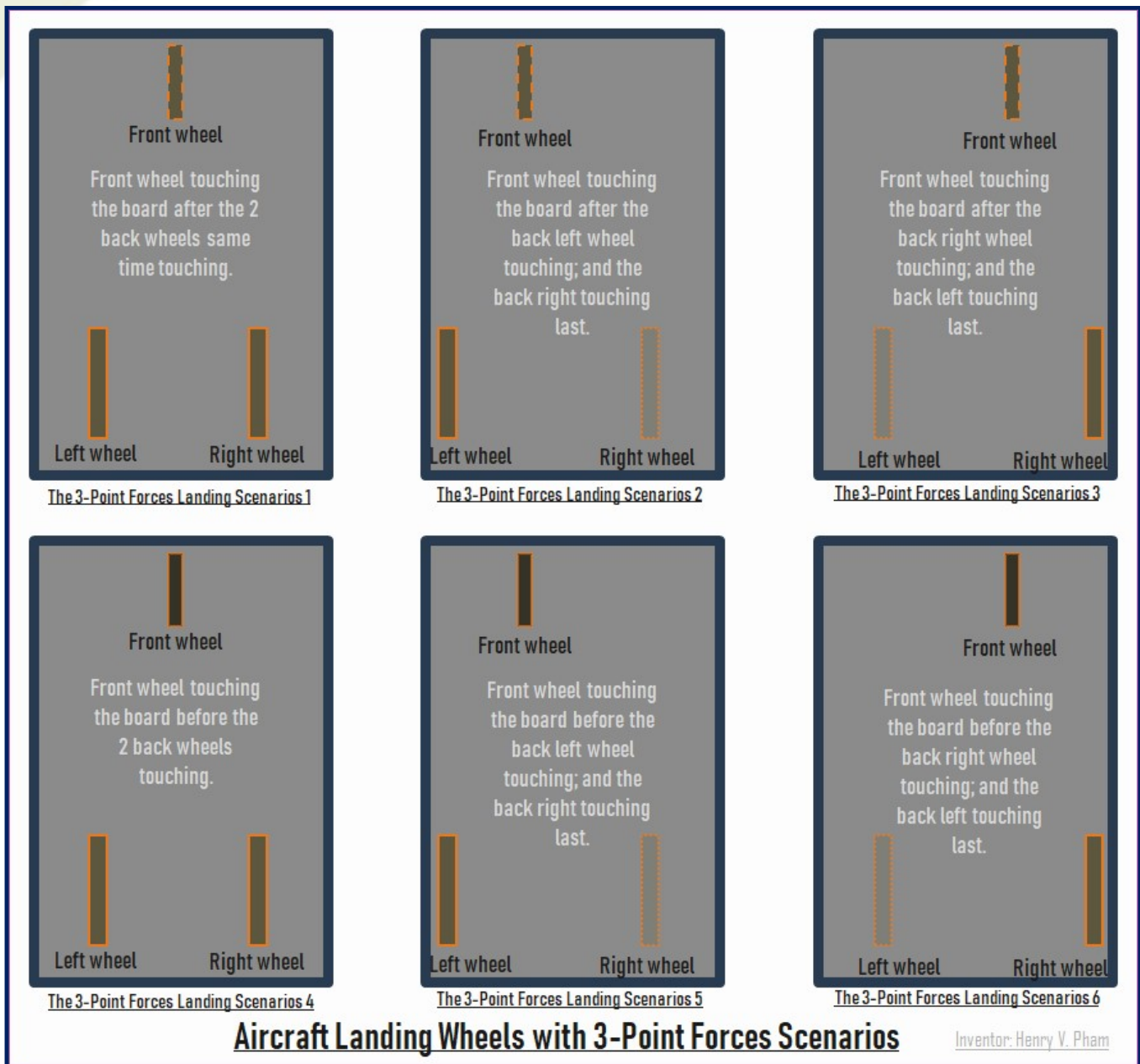

Figure-D5: Touch-Slide & Landing Board Landing Wheels with 3-Point Forces Scenarios

Figure-D6: Recommended Aircraft with Front Camera for Front Lower View shows a view of aircraft elevating at 15° degrees with recommended front camera for front lower view which can able to view from 90° to 120° degrees. To eliminate pilot blind spots while takeoff or landing, front lower camera suggestion can be the best to eliminate the blind spots and provided the pilot with a better and closer view of the TSL board while landing.

Touch-Slide & Landing Board for Aircraft Carrier

Henry V. Pham

-- Specification --



Figure-D6: Recommended Aircraft with Front Camera for Front Lower View

E. Additional Accelerator Board for Aircraft Carrier

Figure-E1: Additional Accelerator Board for Takeoff faster shows the Accelerator board in both top and side views. Aircraft landing is critical on aircraft carrier which has limited in length; additional Accelerator board is also great for aircraft to takeoff in a shortest distance to save space on the aircraft carrier. The width of the Accelerator board should be the width of the 2-back wheels of the largest supported aircraft plus at least 2 feet on both sides; the Accelerator board can have all gears drive to have more power to accelerate; and the step board should have enough friction to prevent the aircraft from slipping. The step board panels can be built and connected like tank chain belt but connect closer to each other as possible to prevent debris dropping in. The Accelerator board can be built to roll as fast as possible to reduce the takeoff distance while the aircraft uses the wings to takeoff when the aircraft moving at a satisfied takeoff speed plus the elevation of the aircraft carrier at the edge of the aircraft carrier which is expected at the front edge of the Accelerator board.

Touch-Slide & Landing Board for Aircraft Carrier

Henry V. Pham

-- Specification --

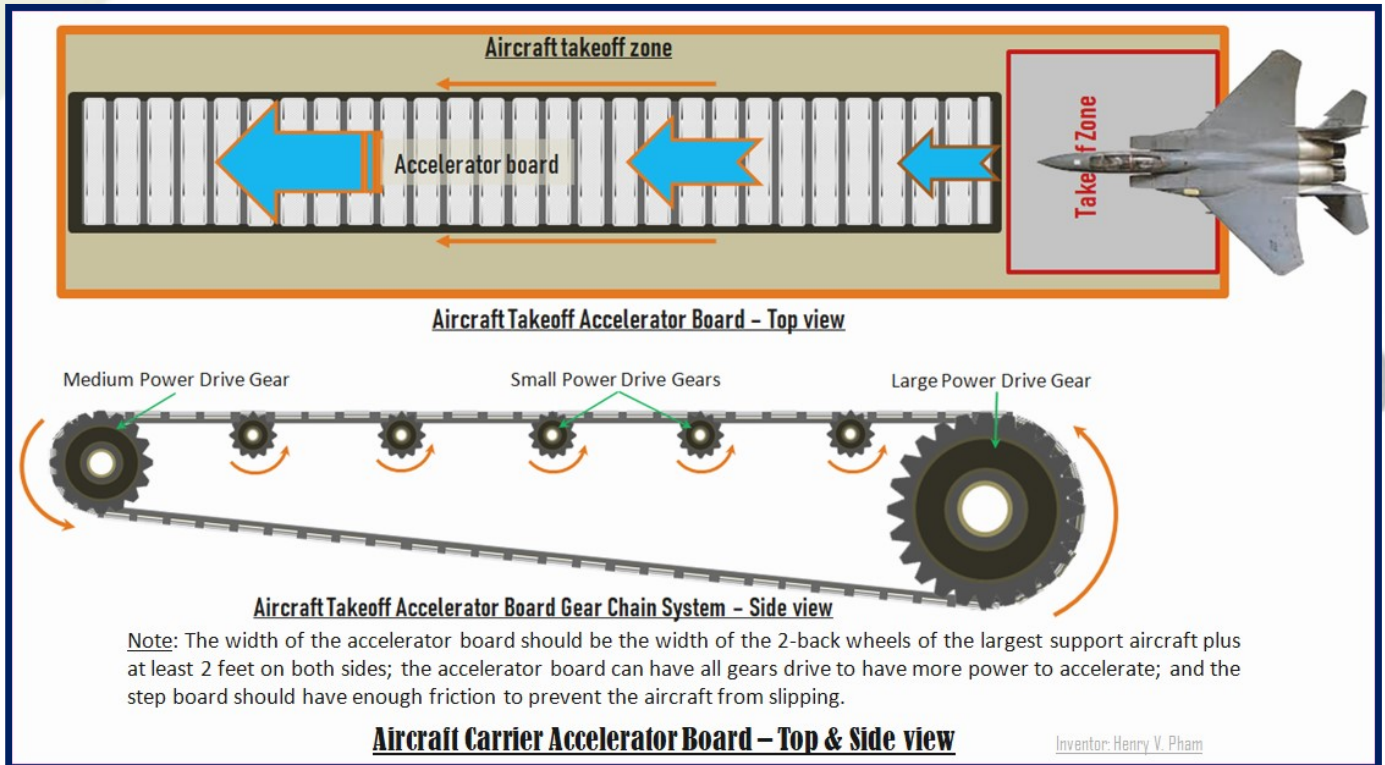

Figure-E1: Additional Accelerator Board for Takeoff faster

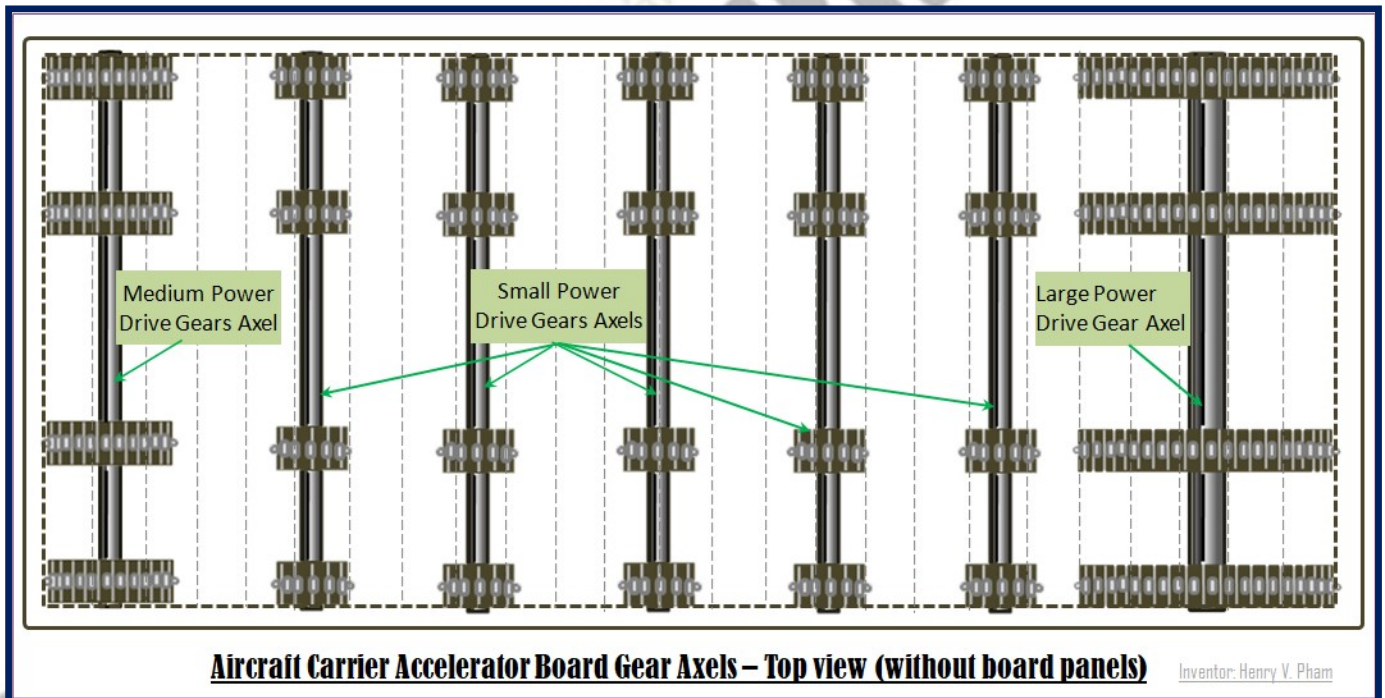

Figure-E2: Accelerator Board Gear Axes – without board panels

Figure-E2: Accelerator Board Gear Axes – without board panels shows the Accelerator board gear axes which are recommended to build separated by maximum of 5 meters axel-to-axel space; the space in between can

Touch-Slide & Landing Board for Aircraft Carrier

-- Specification --

be built with rollers to reduce friction. The rollers can be added in between the small power drive gear axels. The small power drive gear axels are used to pull the accelerator panels forward on the horizontal surface; the medium power gear axel is used to roll and turn the Accelerator board to the lower angle so the large power drive gear axel can take and roll back. The large power drive gear axel can be built with adjustable space to increase or decrease the tension of the accelerator chain belt. An additional chain belt adjuster can be built at lower chain belt within medium and large axels; however, this additional adjuster may introduce another friction force unnecessarily. The Accelerator board panels are recommended to build with lightweight strong material with urethane coating surface for high friction. The accelerator gears sizes can be adjusted based on the deep floor available of the aircraft carrier and keep the speed of rolling as fast as possible to reduce the distance and provide more space for aircraft carrier. Note that while aircraft carrier may has persons working around the Accelerator board, a chain nest is recommended at the edge of the aircraft carrier right at the outer edge of the Accelerator board for safety purposes. The safety space between the Accelerator board and the position of the aircraft in prepare-to-takeoff zone is recommended with at least 5 meters from the nose of the aircraft to the inner edge of the Accelerator board.

F. Introduce New Aircraft Carrier Layout

Figure-F1: Introduced New Aircraft Carrier Layout for more space with TSL & ACC boards shows the introduce of new Aircraft Carrier floor layout in V shape which is intended to replace existing aircraft carrier is built with rope/cable catching for landing and cost the large mechanical under aircraft carrier floor in the compartment which is used to attracting and detracting the rope/cable. The Accelerator board is built on the front floor and the Touch-Slide & Landing board is built on the back floor on one side of the Aircraft Carrier to have more spaces and safety purposes. The new aircraft carrier layout has the TSL protection divider with water-filled plastic barriers; this divider is recommended to install along the TSL way as shown in orange blocks with at least 2.5 meters from the tip of the largest supported aircraft and within 1.5 meter tall; this divider can protect the aircraft from crashing on the communication tower or on the inner zones. The regular aircraft carrier length is about 325 meters; and the Accelerator board can be used 50 meters and the TSL board can be about 100 meters; so there are more spaces with the new aircraft carrier layout. Since the new layout has more space, aircraft Elevadoor Entrance is introduced and intended to replace the existing lower entrance on the side of the aircraft carrier. The aircraft Elevadoor Entrance is in circle shape which can be elevated up to the floor and down to the compartment; and this aircraft Elevadoor can rotate the upper circle layer to allow the aircraft can get in or out on any direction for more compact and convenient.

Figure-F2: Aircraft Circle Elevadoor – Base floor scanning view shows the aircraft Elevadoor at the lower level, and the Elevadoor comes with the photo-cam sensors which are used to scan the aircraft to ensure the aircraft is fitted well into the Elevadoor before moving up or down.

Touch-Slide & Landing Board for Aircraft Carrier

Henry V. Pham

-- Specification --

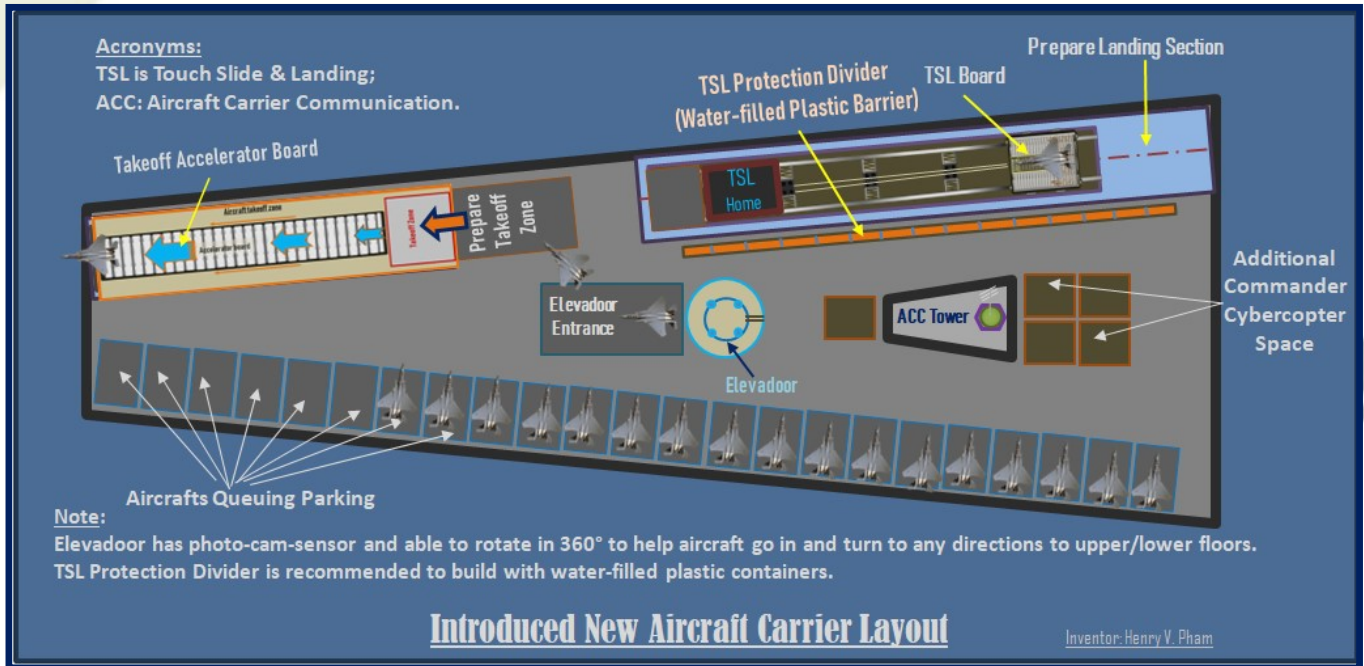

Figure-F1: Introduced New Aircraft Carrier Layout for more space with TSL & ACC boards

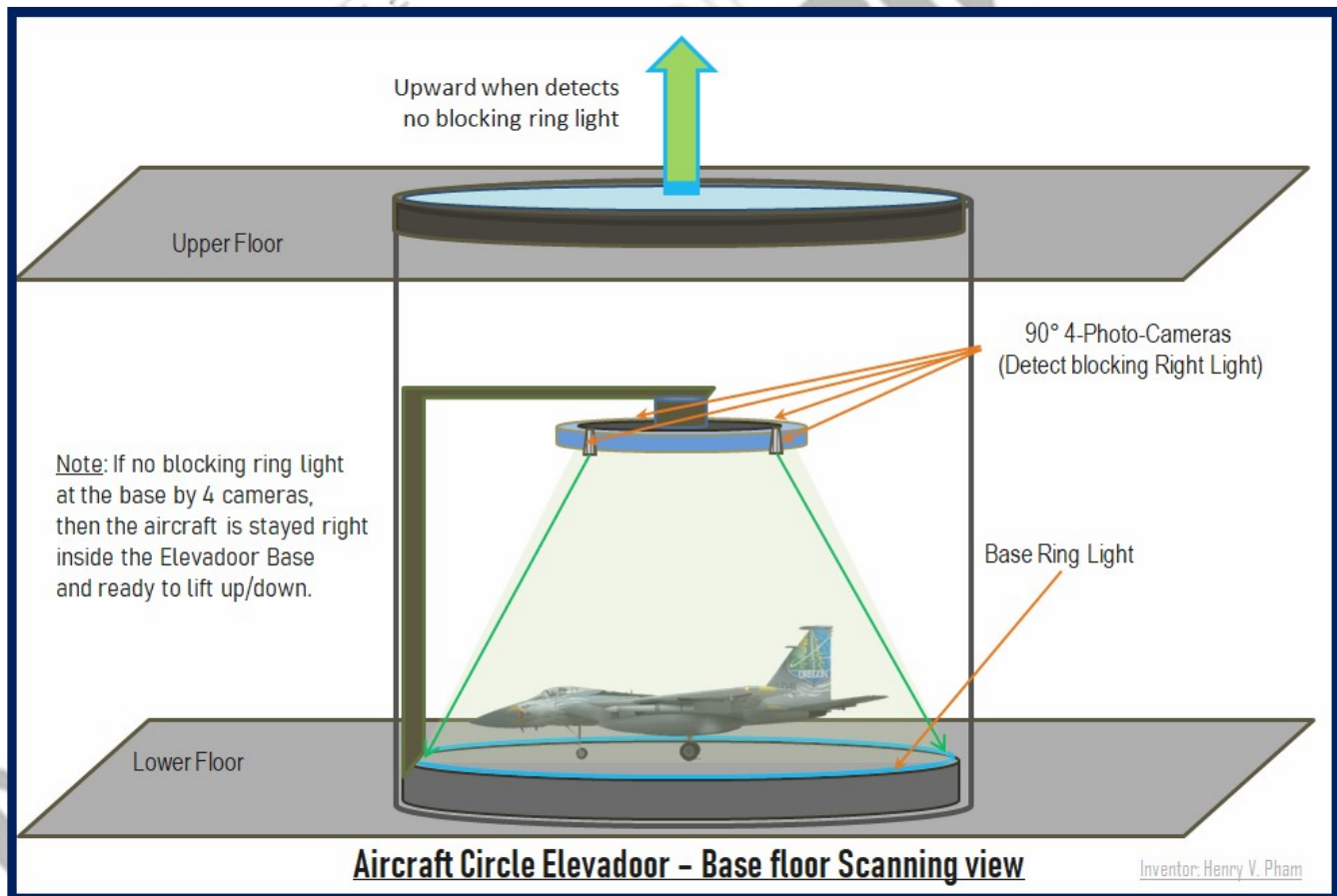

Figure-F2: Aircraft Circle Elevadoor - Base floor scanning view

Touch-Slide & Landing Board for Aircraft Carrier

-- Specification --

Figure-F3: Aircraft Circle Elevadoor - Upper floor scanning view shows aircraft Elevadoor scanning at the upper level floor, and the Elevadoor is elevated by the Multi-level Dual-side E-Power Gear Scissor Liftier. The Dual-side E-Power Gear Scissor Liftier is the scissor lifter will show in later sections. The aircraft Elevadoor base is built with a LED ring in high intensity around the edge of the base; this LED ring is used by the photo-cam sensors to check for any part of the aircraft is outside of the base when scanning the photo for any blocks of the LED ring sections. The photo-cam sensors in this invention document are the 4 cameras on the top holder ring, and the 4 cameras are installed in 90° degrees angle difference; one photo-cam can scan and check on its 90° degrees angle arc which is the base LED ring. The photo-cam holder ring on top can be adjusted with larger holder ring for lower tolerances; however, the photo-cam can be built just one on the ring rack and spin round to scan for more accurate in 360° degrees.

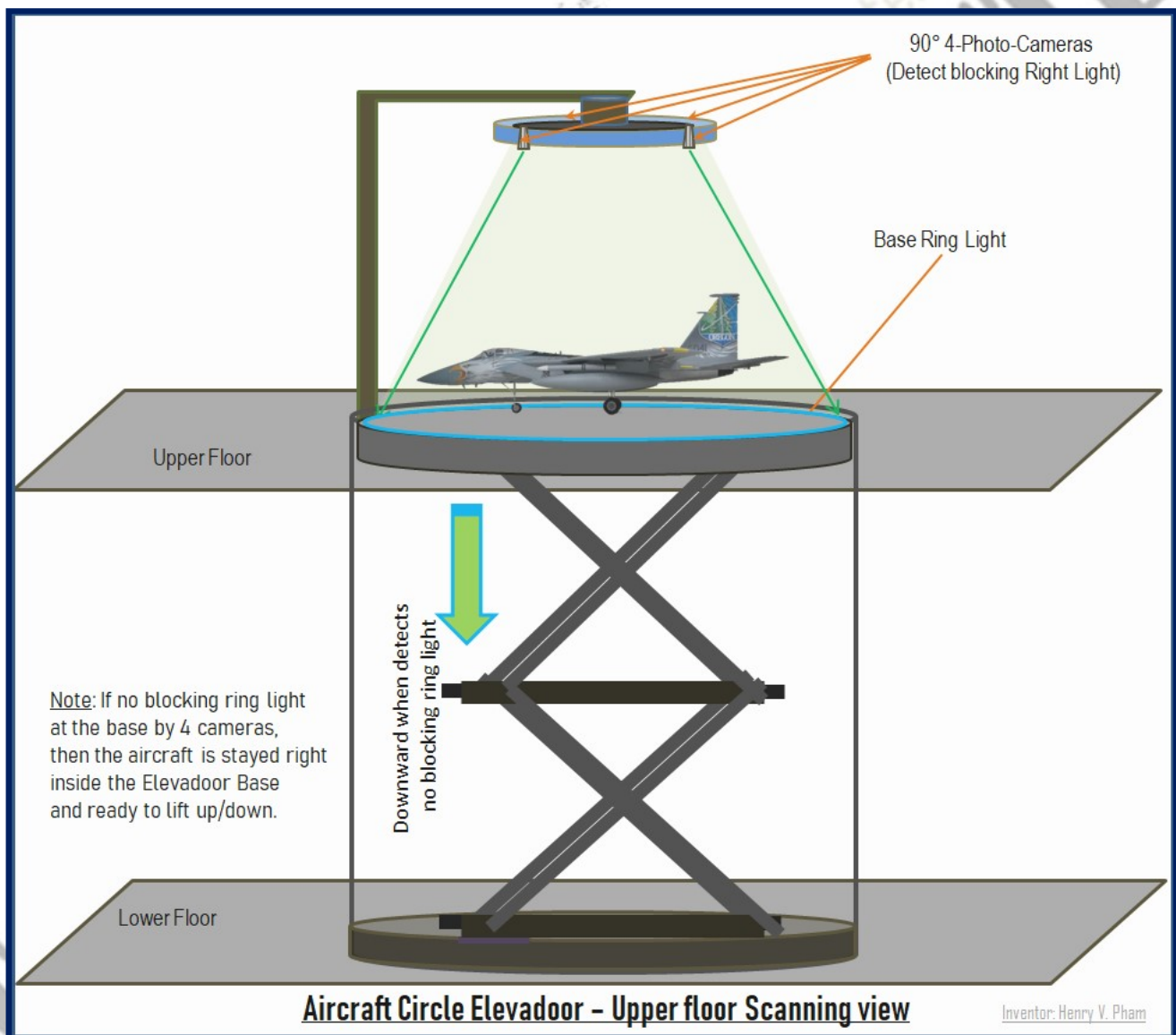

Figure-F3: Aircraft Circle Elevadoor - Upper floor scanning view

Touch-Slide & Landing Board for Aircraft Carrier

-- Specification --

G. E-Power Gear Scissor Lifter (Lift-i-er)

Figure-G1: One-Side E-Power Gear Bar Scissor Lifter shows One-side E-Power Gear Scissor Lifter, and Figure-G2: Both-Sides E-Power Gear Bar Scissor Lifter shows Dual-side E-Power Gear Scissor Lifter. The Touch-Slide & Landing board is needed to use One-side E-Power Gear Scissor Lifter, and the aircraft Elevadoor is needed to use Dual-side Gear Scissor Lifter

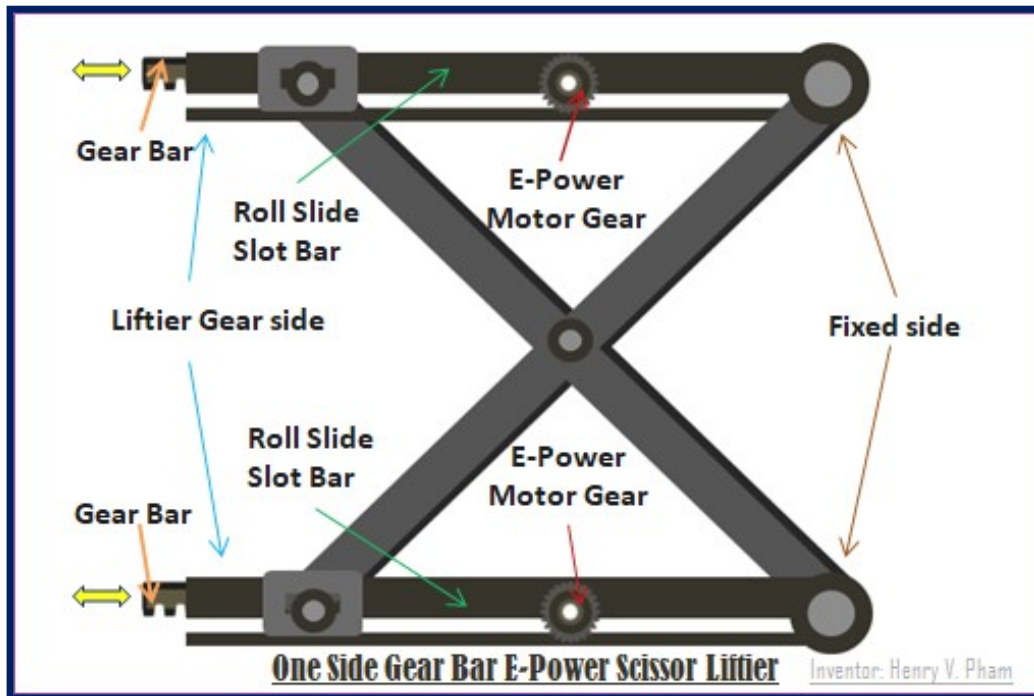

Figure-G1: One-Side E-Power Gear Bar Scissor Lifter

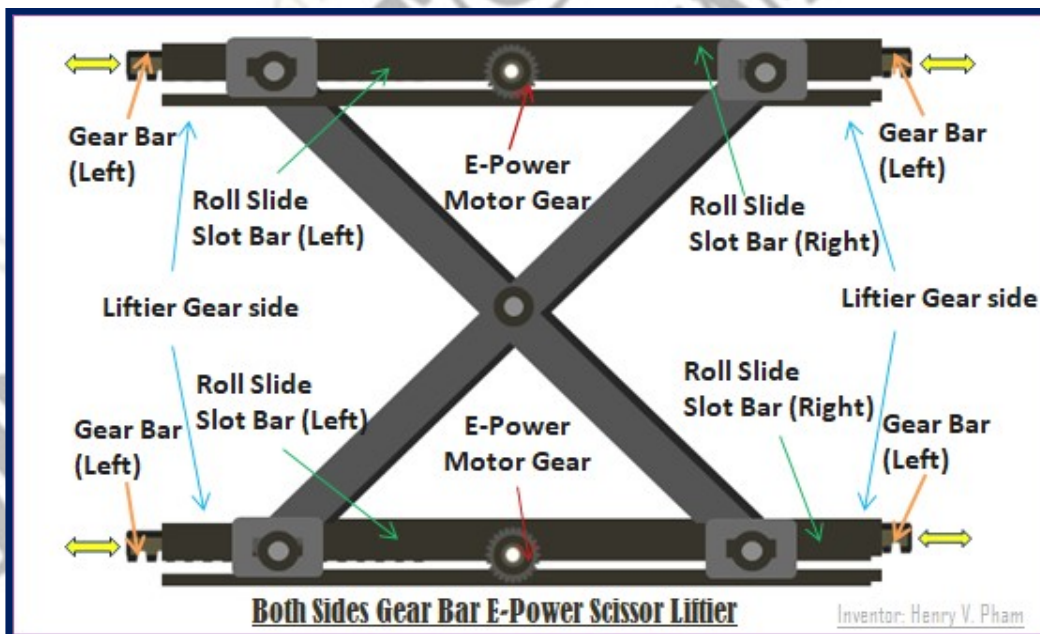

Figure-G2: Both-Sides E-Power Gear Bar Scissor Lifter

Touch-Slide & Landing Board for Aircraft Carrier

Henry V. Pham

-- Specification --

Figure-G3: E-Power Gear Bar Scissor Lifter with Maximum lock which was introduced in my other invention "OH SMART AIRPORT" that comes with the maximum lower lock which allow the lifter lower to certain high and locked right there. There are many other scissor lifters using air lifting, however, E-Power Gear Bar Scissor Lifter is more strong and convenient to use with step motor for more accurate height of elevation.

Figure-G4: E-Power Gear Bar Scissor Lifter – Dual Gear Bar & Directions view shows more details in components of the gear scissor lifter with direction of gear bars and lifting upward or downward. The E-Power Motor Gear turns the Gear Bar to move along the Slide Bar Slot that makes the scissor beam to change their angle; when the motor gear turns the gear bar out, the scissor beams elevated and raised the lifter up; note that the gear bar has one side fixed and attached to one-side joint and the other side open which allows the gear bar to move outward to lift up and reverted to flatten. For Dual-side E-Power Gear Scissor Lifter, there are 2 gear bars that allow the motor gear to turn and move both gear bars in or out at the same time.

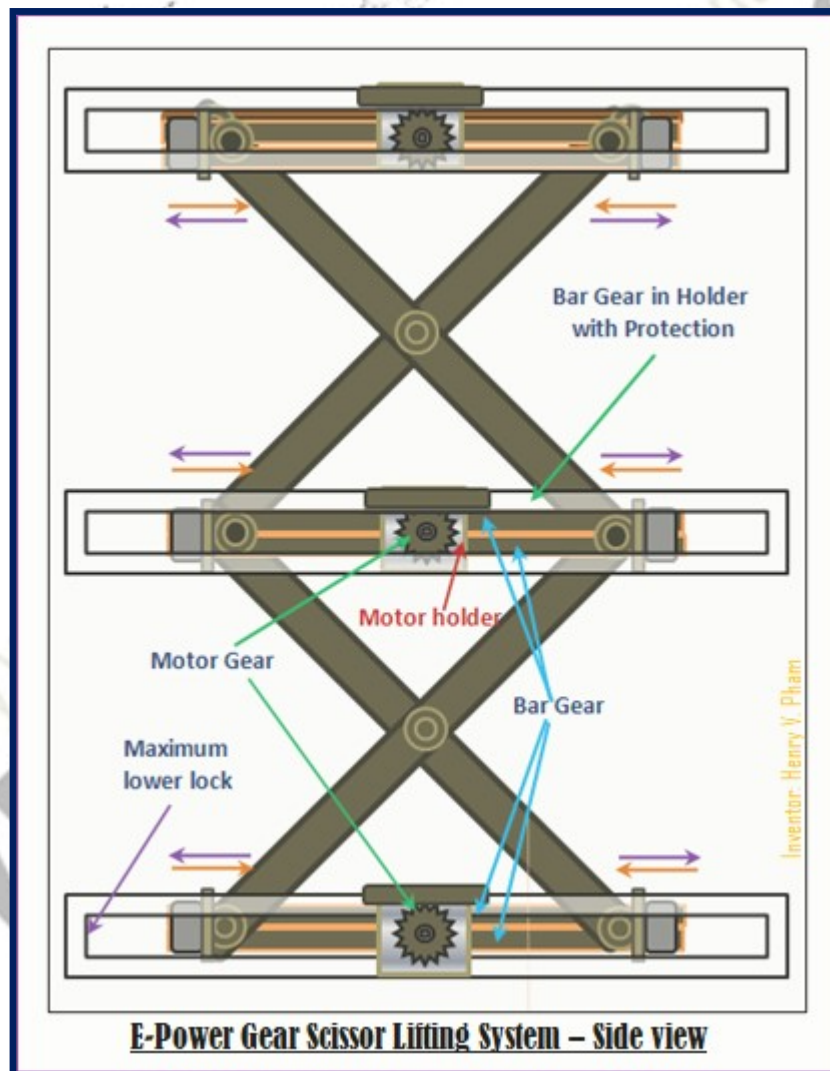

Figure-G3: E-Power Gear Bar Scissor Lifter with Maximum lock

Touch-Slide & Landing Board for Aircraft Carrier

-- Specification --

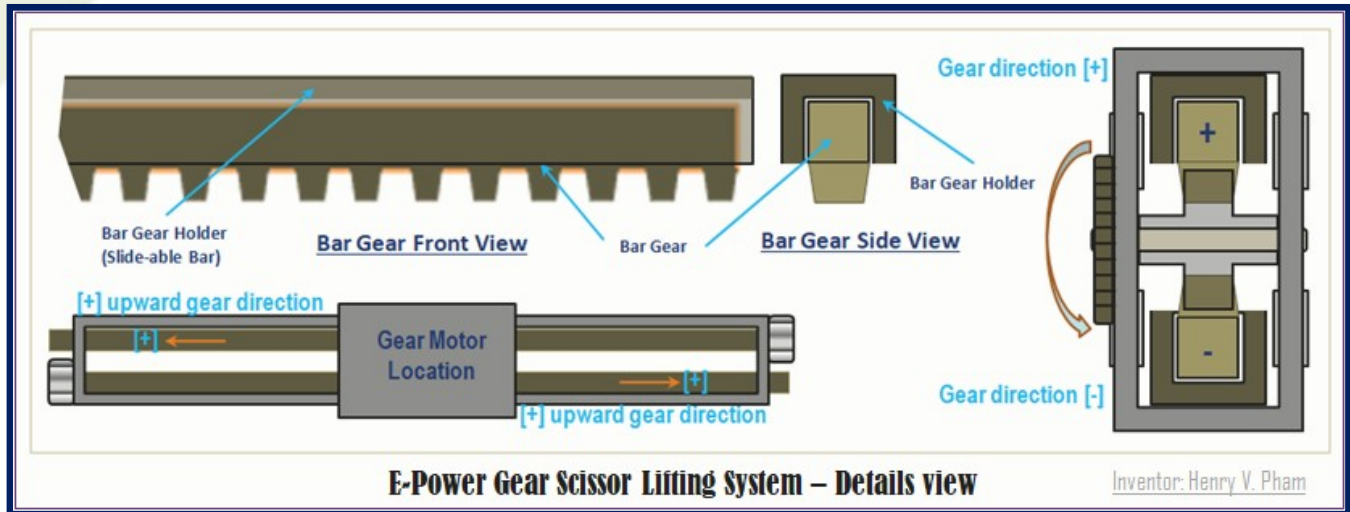

Figure-G4: E-Power Gear Bar Scissor Lifter – Dual Gear Bar & Directions view

Figure-G5: Additional Roller Slide Slot Bar which was introduced in my other invention “Cybercopter Flyer”, shows the Roller Slide Slot with a roller layer on base of the slot. The roller layer base is wider which contains array of rollers with the locks on both sides; this additional roller slide slot would help the system running smoother with less friction which is highly recommended. The heavy duty Gear Scissor Lifter is recommended with additional Roller Slide Slot which can reduce friction of the bar while sliding in or out.

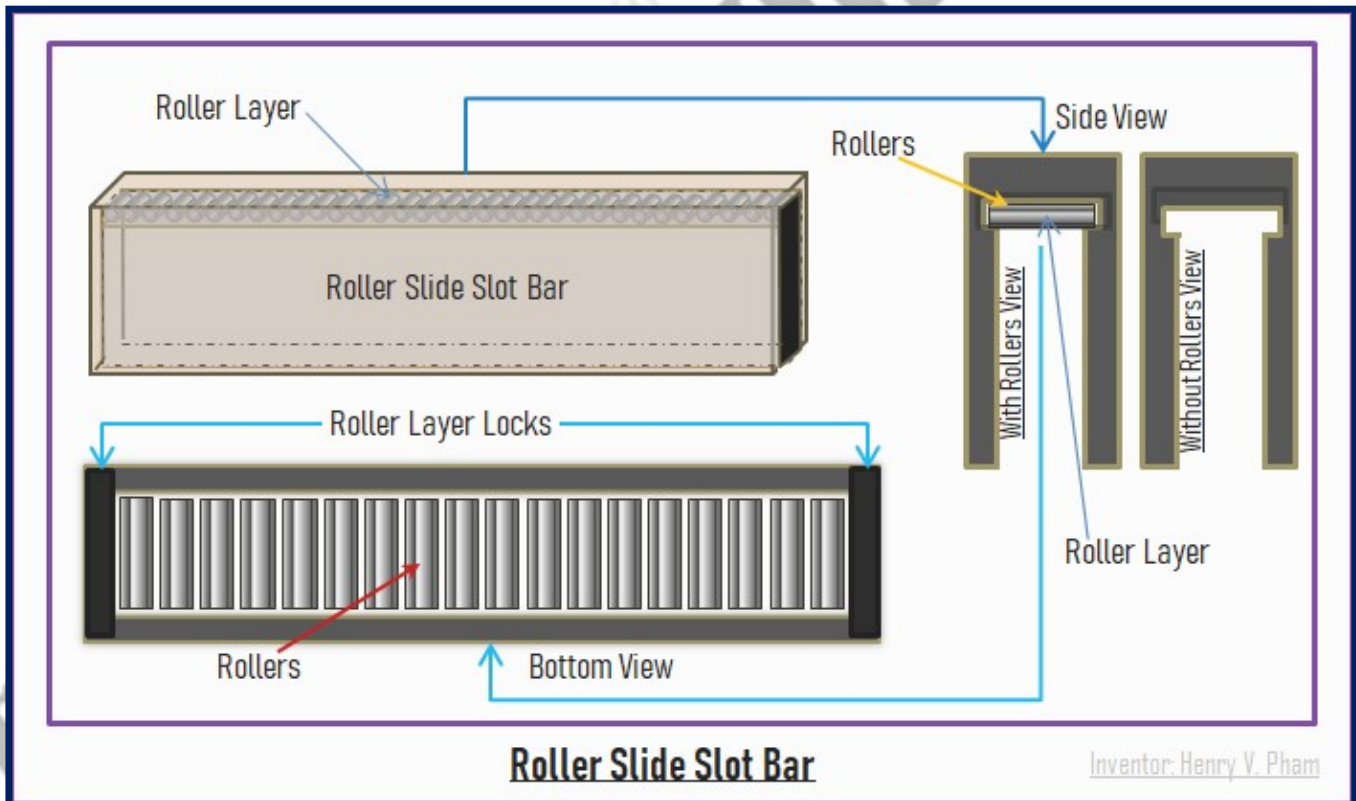

Figure-G5: Additional Roller Slide Slot Bar

Touch-Slide & Landing Board for Aircraft Carrier

-- Specification --

H. Summary

The **Touch-Slide & Landing Board for Aircraft Carrier** is intended to replace the existing rope/cable catching aircraft for landing with the great gradually slide-to-stop methodology on the railroad that gradually wider on the other side which can automatically stop the sliding board eventually with less shocks in the shortest distance on the aircraft carrier. The TSL board is recommended to build with strong lightweight material with the rubber helper wheels attached to the base frame that can be used to initiate the initial speed of the board at the moment the aircraft touching that sliding board as needed, and the rail wheels rolling on the railroad when the aircraft touching the sliding board. The sliding board is set at an angle and should be always charged at the ready position at the charger station which provides electrical battery power to the TSL board mechanical that can able to flatten the sliding board and bring the entire sliding board to the landing home before the aircraft can get to the aircraft carrier floor. This invention also provides the **Accelerator Board** to help aircraft takeoff faster, plus the new introduced aircraft carrier layout. For existing Aircraft Carrier, the Accelerator Board is recommended to build on the front of the aircraft carrier, and the Touch-Slide & Landing Board is recommended to build on the existing landing way with the same as existing landing direction. The aircraft carrier is recommended to provide with hand tugs to help towing the aircraft to the desired space to more organized aircraft parking after landing. The aircraft is also recommended to have at least a front lower view camera; this camera would help the pilot having a better landing view or ground view while takeoff or landing to eliminate the blind spots. The existing rope catching for aircraft landing is dangerous and cost more spaces, more resources, cost the aircraft and pilot's life as shown rope/cable broke while landing in the references section; and even lost the battle when the rope is broken while landing. With these **Accelerator Board** and **Touch-Slide & Landing Board**, the aircraft can takeoff faster and landing safer in the shortest distance to reduce crashed with reducing space of rope extracting and detracting mechanism under the aircraft carrier floor in the compartment. This invention is the great promise for the future of aircraft carriers for better landing and takeoff in shortest distance with more space on the aircraft carrier which can provide better and safer for the pilots and commanders deploying troops for **peacean** keeper around the world through the ocean with more confident.

I. References

1. New words are introduced in this invention document, 'Elevadoor' is the door in the elevator, and 'Liftier' is the Lift-i-er lifting system.
2. The E-Power Scissor Liftier was introduced in my invention "**OH SMART AIRPORT**", and the Roller Slide Slot Bar was also part of my other invention "**Cybercopter Flyer**" which was posted on the website www.TheCybercopterFlyer.com; For more detail about this invention and my other inventions, please visit my website www.TheCloudOSCenter.com;
3. This invention, "Touch-Slide & Landing Board for Aircraft Carrier" is invented to provide better way of landing on the aircraft carrier in a shortest distance to prevent crashing like the traditional landing by

Touch-Slide & Landing Board for Aircraft Carrier

Henry V. Pham

-- Specification --

rope/cable catching. Figures below were collected from the internet which are shown the aircraft landing with either rope/cable broke or uncatchable rope/cable which may cause crashed or death landing.

Figure-1: Aircraft Landing broke the rope/cable shows the aircraft landing broke the rope/cable.

Figure-12: Aircraft missed catching rope/cable shows the aircraft missed catching the rope/cable.

Figure-13: Aircraft Carrier mechanism handles detracting & pulling rope/cable before and after landing shows the aircraft carrier mechanism that costs lot of spaces under the compartment of the aircraft carrier.



Figure-1: Aircraft Landing broke the rope/cable

Touch-Slide & Landing Board for Aircraft Carrier

Henry V. Pham

-- Specification --



Figure-I2: Aircraft missed catching rope/cable

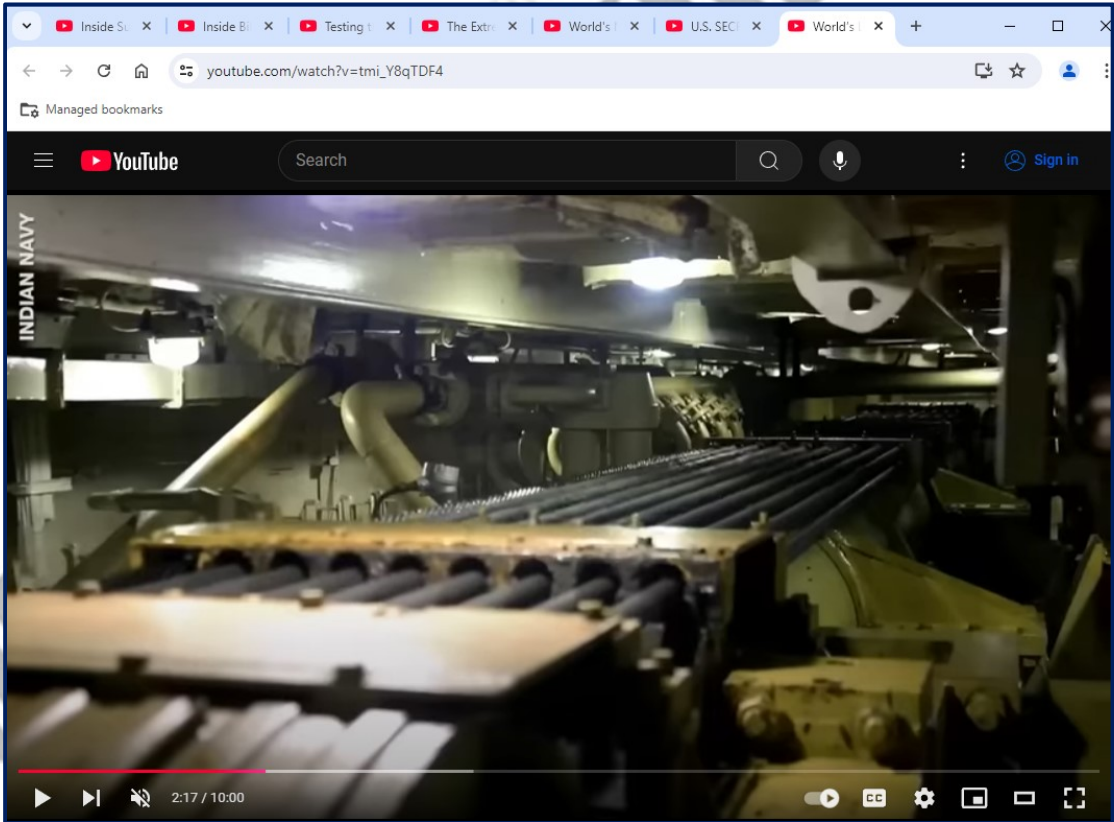

Figure-I3: Aircraft Carrier mechanism handles retracting & pulling rope/cable before and after landing

Touch-Slide & Landing Board for Aircraft Carrier

-- Specification --

J. Biography



About myself, my full name is Henry Viet Pham, original name was 'Viet Hong Pham', changed in 1996 when obtained U.S. citizenship, and currently live in Anaheim, California. I am a father of 3 sons, Alexander Le Pham, Andrew Le Pham, and Harry Quoc Pham and my wife Celine Nguyet Tran. I was born in Vietnam at Dang Nang city in 1972/08/23, then moved to my grandfather's hometown with the family right after the South Vietnam collapsed in 1975 and grown up at Binh My, Binh Son, Quang Ngai; and I came to United States in 1991 as a military and political immigrant with my father and family members. My father Nu Pham who served as a Lieutenant in military during Vietnam War in 1975, and my mother is Thong Thi Tran with my sisters are Nguyet Thi Pham, Jessie Nga Pham and Tiffany Tuyen Pham, and my brothers are Duc Hong Pham, Kevin Tri Pham, Danny Phuc Pham, and Andy Quy Pham.

About Education, I came to United States after finished my high school at TPTH Binh Son in 1989 at Quang Ngai, Vietnam; and I continued my education right after came to U.S. and I got my Bachelor Degree in Electrical and Computer Engineering at Calpoly Pomona, California in 1998. I am interested in Engineering and Science, and I have done many researches and self-study since I graduated in 1998 and continue researching and inventing with total of 13 inventions which have been submitted for patents from June 2021 to September 2024, and I still have many other inventions to work on and open the Cloud OS Company for business.

About my works and inventions, I have over 25 years of professional experience in high technology industry since 1998. I have worked for Eden Airport Ground Service Company in Los

Touch-Slide & Landing Board for Aircraft Carrier

-- Specification --

Angeles Airport in 1995; worked for Caltrans in 1997; worked for Raytheon, a defense company from year 1998 to 2005; worked for Marshal 8e6, an internet security company from year 2006 to 2010; worked for Pace America, a Satellite Set Top Box in 2010; and worked for Western Digital, a storage technology company, from year 2010 to 2024. I am a sole inventor of a total of 15 inventions which have been submitted from June 2021 to November 2024 as followings.

1. Invention Title: New Way to protect WiFi Network from Hackers - Submission with U.S. Patent PCT No.: 29/788,607; Submitted on: 2021/07/01; and resubmitted on 2024/02/27 to WIPO international office with U.S. Patent PCT No.: PCT/US24/17533 and International Patent: PCT/IB2024/000110;
2. Invention Title: THE G-CODE - First submission with U.S. Patent PCT No.: 29/806,573 => then resubmitted with PCT/US22/70704; and International Patent: PCT/IB2022/000112; Submitted on: 2021/09/03;
3. Invention Title: The Cloud OS - Operating System - Submission with U.S. Patent PCT No.: PCT/US21/71689; and International Patent: PCT/IB2021/000683; Submitted on: 2021/10/02;
4. Invention Title: The LPS - Local Positioning System - Submission with U.S. Patent PCT No.: PCT/US21/72562; and International Patent: PCT/IB2021/000949; Submitted on: 2021/11/23;
5. Invention Title: Greatest Performance Hard Drive (G-Drive) - Submission with U.S. Patent PCT No.: PCT/US21/72563; and International Patent: PCT/IB2021/000961; Submitted on: 2021/11/23;
6. Invention Title: Cell eMap Live Updates System - Submission with U.S. Patent PCT No.: PCT/US22/79368; and International Patent: PCT/IB2022/000685; Submitted on: 2022/11/07;
7. Invention Title: LPS Navigation System - Submission with U.S. Patent PCT No.: PCT/US22/79369; and International Patent: PCT/IB2022/000671; Submitted on: 2022/11/07;
8. Invention Title: Emergency Traffic Lights Routing System - Submission with U.S. Patent PCT No.: PCT/US22/82343; and International Patent: PCT/IB2022/000791; Submitted on: 2022/12/23;
9. Invention Title: G-ROUTING ALGORITHM METHODOLOGY -- Submission with U.S. Patent PCT No.: PCT/US22/82347; and International Patent: PCT/IB2022/000800; Submitted on: 2022/12/23;
10. Invention Title: Parallel Transforming Percentage Theorem -- Submission with U.S. Patent PCT No.: PCT/US23/77057; and International Patent: PCT/IB2023/000611; Submitted on 2023/10/23;
11. Invention Title: Auto Following Motion Security Camera -- Submission with U.S. Patent PCT No.: PCT/US24/13660; and International Patent: PCT/IB2024/000177; Submitted on: 2024/01/31;
12. Invention Title: Wall Security Camera System -- Submission with U.S. Patent PCT No.: PCT/US24/13663; and International Patent: PCT/IB2024/000096; Submitted on: 2024/01/31;
13. Invention Title: OH SMART AIRPORT -- Submission with U.S. Patent PCT No.: PCT/US24/43532; and International Patent: PCT/IB2024/000451; Submitted on: 2024/08/23;
14. Invention Title: Touch Slide & Landing Board for Aircraft Carrier -- Submission with U.S. Patent PCT No.: PCT/US24/52509; and International Patent: PCT/IB2024/000586; Submitted on: 2024/08/23;

Touch-Slide & Landing Board for Aircraft Carrier

-- Specification --

15. Invention Title: Cybercopter Flyer -- Submission with U.S. Patent PCT No.: PCT/US24/52515; and International Patent Number is still waiting for WIPO assigned a number; Submitted on: 2024/08/23;

My other inventions are listed as followings, “Hybrid Air & Rubber Cells Layer Tire” which is intended to replace current tire to help prevent flat tires, “Emergency Cylinder Helical Stair” which is used in OH SMART AIRPORT and for commercial use for personal and emergency purposes, “Personal One Step Escalator” which is intended to provide personal use like elevator in compact space, “Smart Cart Gear Belt System” which is used in OH SMART AIRPORT and intended to use for commercial for Smart Cart Exchanger, “Transpond License Plate” which is intended to use for tracking license plate within a desired distance, “Auto Tracking Target Network Security Cameras System” which is intended to use in the crowd areas like airport to follow and track the suspect/target for crowd security camera system, “Robot Medical Doctor” which is intended to help family doctors and hospital to check up patients faster with better medical statistic data with built-in Machine Intelligence (MI), and direct business related inventions, “Matrix Base Keyboard” to prevent wire/wireless keystrokes logger and “One Round Chamber” for data storage hard drive (one of my invention ‘Greatest Performance Hard Drive’) tester.

About my business, the Cloud OS Company (website: www.TheCloudOSCenter.com) business uses mainly Invention #3: The Cloud OS – Operating System, Invention #5: Greatest Performance Hard Drive (G-Drive), and Invention #9: G-ROUTING ALGORITHM METHODOLOGY. The Cloud OS Company business brings the world to the next level of World Computing Infrastructure Modern with the main purposes to secure users’ data and secure entire computer networking around the world or the World eWeb with the new technology of Neighbor-to-neighbor checking methodology and Neighbor-to-neighbor routing technology, and applying the new dynamic protocol technology for data transferring with the high secure of the 4K Number Encryption. And there are my other 3 businesses related websites www.TheGCODECreator.com which is used for the G-CODE labels/profiles/products/logos creator application; www.ThePatrolCircle.com which is used to patrol the points of interests for security camera system with Patrol Circle Unmanned Aircraft; and www.TheCybercopterFlyer.com which is used for Cybercopter Flyer, the Cybercopter flyer is intended to replace the current helicopters and for future of aviation transportation in circle shape like UFO flyers which can support both turbofan and turbojet engines with cell fuel and solar energy.